

ASSEMBLY INSTRUCTION

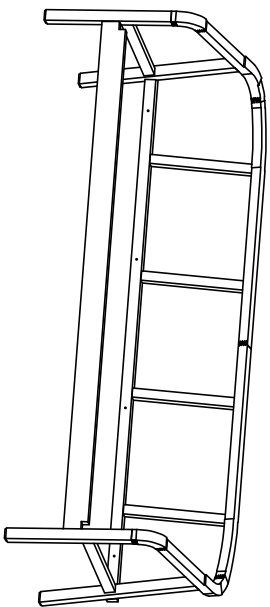

101|x1

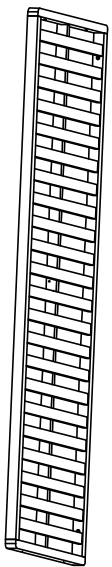

102|x1

103|x1



104|x3

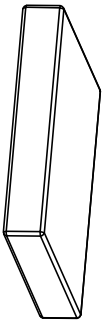

105|x3

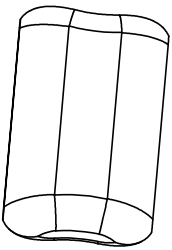

*Hardware

A		Ø6x50	x 08
----------	--	-------	------

B		Ø6x35	x 02
----------	--	-------	------

C		Ø4mm	x 1
----------	--	------	-----

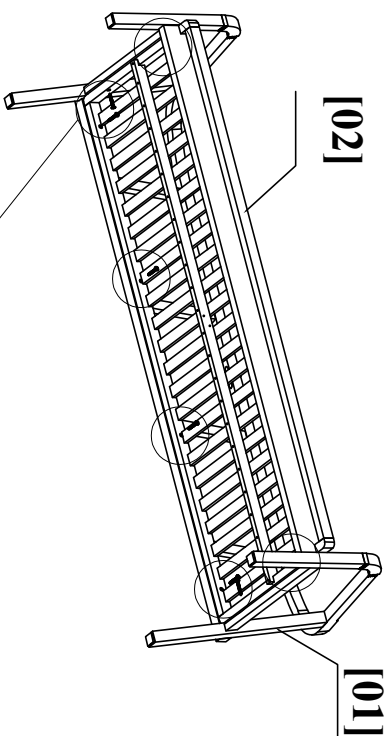

1

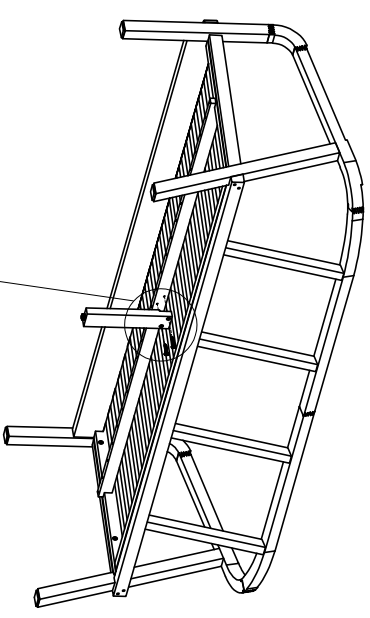

2

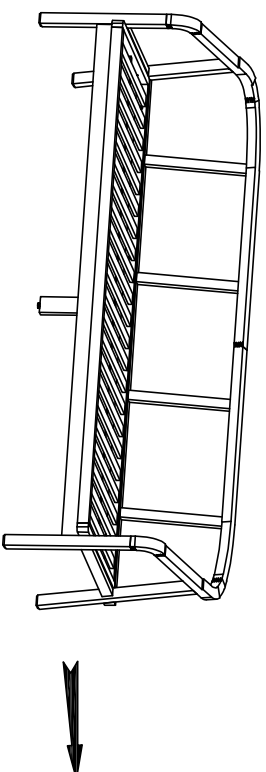

3

