

# INDUSTRY ENCLOSURES

## 工业机柜系列

前门后背板工业机柜

前门后门工业机柜



SAIP ELECT.

Copyright © Saip ELEC. All Right Reserved  
Deliver happiness to everyone



- 表面处理：纳米薄膜技术+阴极电泳技术+表面喷粉工艺
- 框架结构：9折型材框架，静态承重达到1000公斤  
16折型材框架，静态承重达到1500公斤
- 防护等级：IP55、IK08
- 开门方向：可随时变换门的开启方向，实现上下左右全面并柜
- 可选配置：冷轧钢板、不锈钢
- Surface Treatment: Nano-film technology + Cathodic electrophoretic coating technology + Powder coating process
- Frame Structure: 9-fold profile frame with a static load capacity of 1000 kg  
16-fold profile frame with a static load capacity of 1500 kg
- Protection Rating: IP55, IK08
- Flexible Door Opening Direction: The door opening direction can be adjusted at any time, allowing for full cabinet integration in all directions.
- Optional Configurations: Cold-rolled steel plate, stainless steel



材料 Material	冷轧钢板 Cold-roll steel sheet
表面处理 Surface treatment	机柜磷化底涂处理，外部为粉末涂层，颜色可分RAL7032和RAL7035两种织纹，安装板则为镀锌 Cabinet is applied with etch primer and covered with powder coating on the outer side. Two color textures, RAL7032 and RAL7035, are available. The mounting plate is galvanized.
防护等级 Protection	IP65 (符合IEC 60529) NAME 4 IP65 (Acc to IEC 60529) NAME 4
标准配置 Standard configuration	前门、背板、安装板、柜体、门锁、密封条 Front door, back plate, mounting plate, cabinet, door lock, sealing strip
钢板厚度 Plate thickness	框架：五折型材1.5mm 门板：2.0mm 背板：1.5mm 安装板：2.5mm Frame: 5-fold sections 1.5mm Door plate: 2.0mm Back plate: 1.5mm Mounting plate: 2.5mm



### 产品特点 Features of Products

- 独立式全封闭构造，顶盖与各面一体成型，结合五折型材整体焊接框架，确保柜体高强度与优异稳定性
- 一体化焊接工艺显著提升密封效果，整柜防护等级可达 IP65
- 框架均布 25mm模数安装孔，实现内部安装的高灵活性与广泛通用性
- 镀锌安装板采用导轨前端推入结构，配合U型折边加强设计，安装稳固、搬运便捷，并兼容 KP/KT系列机柜系统

- Fully enclosed free-standing design with integrated top and side panels, combined with a welded 5-fold profile frame, ensuring high strength and excellent structural stability
- One-piece welding process enhances sealing performance, achieving a protection level up to IP66
- Frame features a 25mm pitch modular hole pattern, enabling flexible and universal internal installation
- Galvanized mounting plate adopts a front sliding rail insertion design with reinforced U-shaped edges, ensuring secure installation and easy handling, compatible with KP and KT cabinet systems

### KD系列订货规格表

#### KD series order specification table

\*可定制非标产品  
Nonstandard products are customizable

序号 No.	订货号(KD) Order number (RAL7032)	订货号(KD) Order number (RAL7035)	宽 Width	高 Height	深 Depth
1	KD601640102	KD601640105	600	1600	400
2	KD601650102	KD601650105	600	1600	500
3	KD601840102	KD601840105	600	1800	400
4	KD601850102	KD601850105	600	1800	500
5	KD602050102	KD602050105	600	2000	500
6	KD602060102	KD602060105	600	2000	600
7	KD801450102	KD801450105	800	1400	500
8	KD801650102	KD801650105	800	1600	500
9	KD801840102	KD801840105	800	1800	400
10	KD801850102	KD801850105	800	1800	500
11	KD801880102	KD801880105	800	1800	800
12	KD802050102	KD802050105	800	2000	500
13	KD802060102	KD802060105	800	2000	600
14	KD802080102	KD802080105	800	2000	800
15	KD802260102	KD802260105	800	2200	600
16	KD101840112	KD101840115	1000	1800	400
17	KD121450112	KD121450115	1200	1400	500
18	KD121650112	KD121650115	1200	1600	500
19	KD121840112	KD121840115	1200	1800	400
20	KD121850112	KD121850115	1200	1800	500
21	KD122050112	KD122050115	1200	2000	500
22	KD122060112	KD122060115	1200	2000	600
23	KD122260112	KD122260115	1200	2200	600



材料 Material	SUS304 (其它材料型号可选) SUS304 (other material types are optional)
表面处理 Surface treatment	拉丝, 安装板则为镀锌 Wire drawing, and mounting plate is galvanized
防护等级 Protection	IP65 (符合IEC 60529) NAME 4 IP65 (Acc to IEC 60529) NAME 4
标准配置 Standard configuration	前门、背板、安装板、柜体、门锁、密封条 Front door, back plate, mounting plate, cabinet, door lock, sealing strip
钢板厚度 Plate thickness	框架: 五折型材1.5mm 门板: 2.0mm 背板: 1.5mm 安装板: 2.5mm Frame: 5-fold sections 1.5mm Door plate: 2.0mm Back plate: 1.5mm Mounting plate: 2.5mm



KD不锈钢系列订货规格表

KD Stainless steel series order specification table

\*可定制非标产品  
Nonstandard products are customizable

序号 No.	订货号(BKD) Order number (BKD)	宽 Width	高 Height	深 Depth
1	KD60164010S	600	1600	400
2	KD60165010S	600	1600	500
3	KD60184010S	600	1800	400
4	KD60185010S	600	1800	500
5	KD60205010S	600	2000	500
6	KD60206010S	600	2000	600
7	KD80145010S	800	1400	500
8	KD80165010S	800	1600	500
9	KD80184010S	800	1800	400
10	KD80185010S	800	1800	500
11	KD80188010S	800	1800	800
12	KD80205010S	800	2000	500
13	KD80206010S	800	2000	600
14	KD80208010S	800	2000	800
15	KD80226010S	800	2200	600
16	KD10184011S	1000	1800	400
17	KD12145011S	1200	1400	500
18	KD12165011S	1200	1600	500
19	KD12184011S	1200	1800	400
20	KD12185011S	1200	1800	500
21	KD12205011S	1200	2000	500
22	KD12206011S	1200	2000	600
23	KD12226011S	1200	2200	600

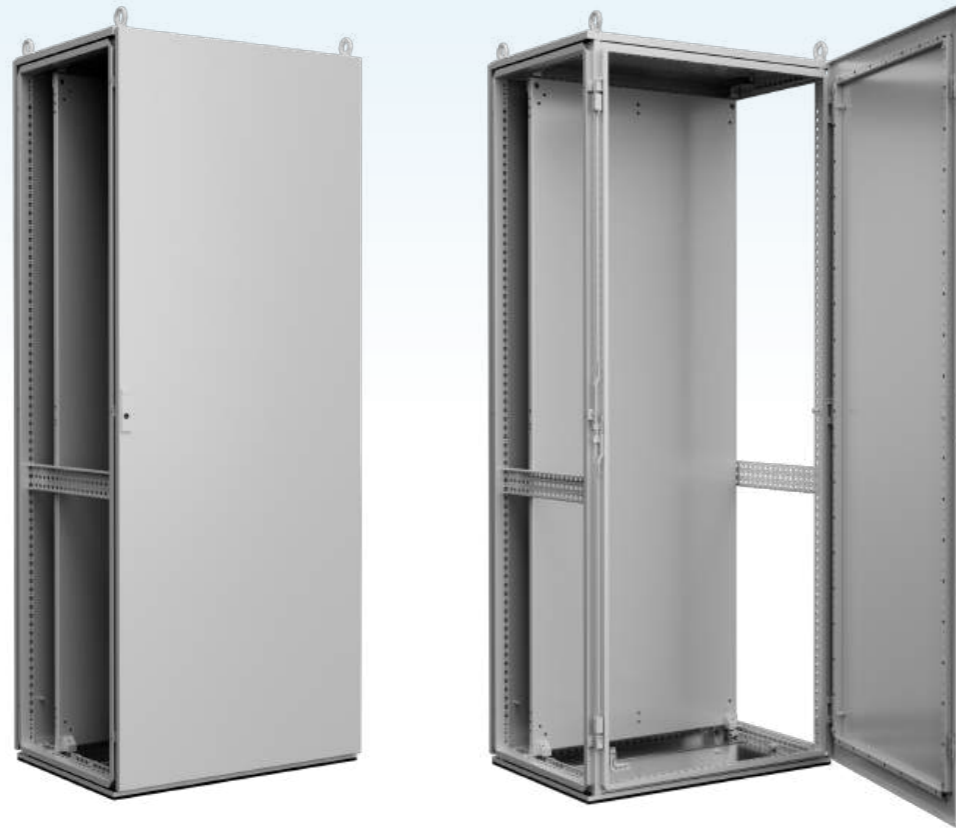

产品特点 Features of Products

- 模块化设计的电柜，可以并联使用
- 独特的拼装结构（也可以选择焊接整装出货），既保证了电柜的尺寸精度和承重性能，又成倍地节约了仓储和运输的空间和成本
- 顶板、侧板和后背板可以拆除，易于工作
- 门板离地高度达到25mm，确保开门灵活顺畅
- 可拆卸的门机板加强筋，方便灵活
- 框架结构有符合国际惯例的25mm间距的模数孔，通用性强安装方便灵活
- 滑入式结构的安装板，方便操作和搬运

- Module industrial enclosure, bayable to left and right without limitation
- The unique knockdown structure reduce about 70% storage space and delivery cost by flat packing (Option: Welded assembly shipment)
- Every enclosure, accessible from all sides, give easy and comforte to the operators
- The distance between the down edge of the door and the floor is 25 mm
- The door can be open and closed smoothly at any condior
- Movable door frame with holes on 25 mm pitch pattern can reinforce the door and give more possibilities for different application
- After installation, mounting plate can be slided in easily

框架安装  
Frame mounting

安装工具

M5梅花批头、手电钻

将四根纵梁如图方向插入前后框架，使用梅花槽沉头三角锁紧螺钉M5×20对孔固定。

Installation tool

1. M5 Torx screwdriver bit and hand drill

2. Insert the four longitudinal beams into the front and rear frames in the orientation shown in the diagram, and secure them through the aligned holes using M5×20 countersunk Torx triangular locking screws.

材料 Material	冷轧板 (其他材料可选) Cold rolled plate (other material are optional)
表面处理 Surface treatment	喷塑、小桔纹、RAL7035 Powder-coated in textured RAL 7035
防护等级 Protection	IP55 (符合IEC 60529) NAME 12 (Type12) IP55 (Acc to IEC 60529) NAME 12 (Type12)
标准配置 Standard configuration	柜体框架、门、安装板、后背板、顶、底 (侧板和底座另选) Frame, front door, mounting plate, rear panel, roof plate, gland plates (Side Wall and Base optional)
钢板厚度 Plate thickness	框架: 九折型材1.5mm 门板: 2.0mm 背板、侧板: 1.5mm 安装板: 2.5mm Frame: 1.5mm Door: 2.0mm Mounting plate: 2.5mm Others: 1.5mm
认证证书 Certification	

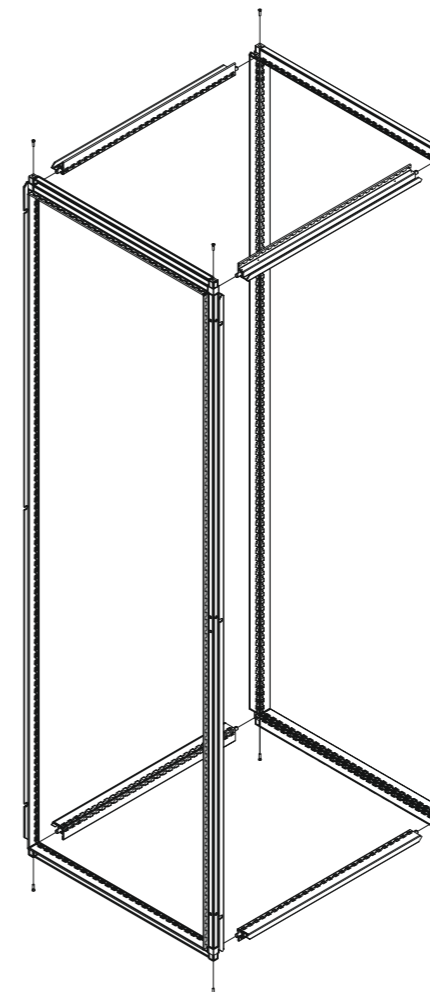
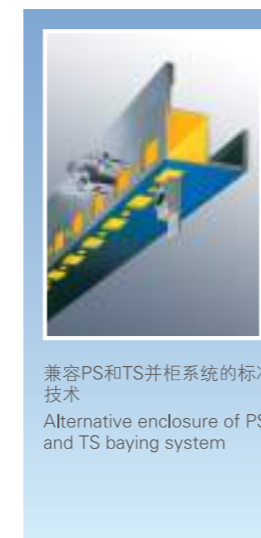
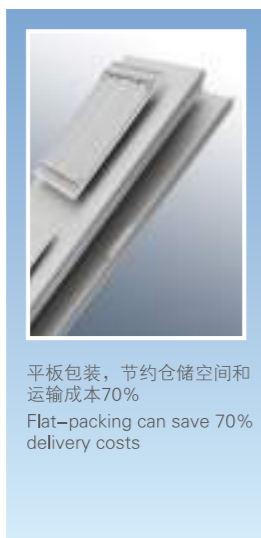

项次 Item number	描述 Description	数量 Quantity
1	梅花槽沉头三角锁紧螺钉M5×20	8个
1	M5×20 Multi-tooth Head taping screw	8 pcs

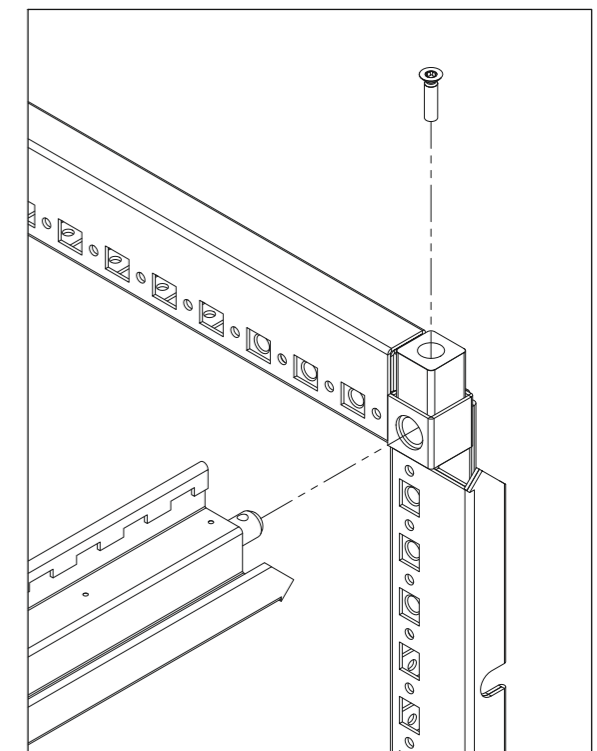



KP系列订货规格表

List of specification of KP enclosures

\*可定制非标产品  
Nonstandard products are customizable

序号 No.	类别 Category	订货号 Order No.	宽 Width (mm)	高 Height (mm)	深 Depth (mm)	供货范围 Supply Includes
1	整柜散装 Complete Enclosure (Flat Packing)	KP601650005	600	1600	500	包括: 前后框2个, 框架深度梁4根, 单开门1扇, 后板1块, 顶板1块, 运输吊环4个, 三段式底板1套, 安装板1块。  Includes: 2 front/rear frames, 4 depth beams, 1 single door, 1 rear wall, 1 roof, 4 eye-bolt, 1 bottom, 1 mounting plate. RAL 7035
2		KP601850005	600	1800	500	
3		KP601860005	600	1800	600	
4		KP602040005	600	2000	400	
5		KP602050005	600	2000	500	
6		KP602060005	600	2000	600	
7		KP602080005	600	2000	800	
8		KP802260005	600	2200	600	
9		KP801450005	800	1400	500	
10		KP801650005	800	1600	500	
11		KP801850005	800	1800	500	
12		KP801860005	800	1800	600	
13		KP801880005	800	1800	800	
14		KP802050005	800	2000	500	
15		KP802060005	800	2000	600	
16		KP802080005	800	2000	800	
17		KP802260005	800	2200	600	
18		KP102050015	1000	2000	500	
19		KP102060015	1000	2000	600	
20		KP121450015	1200	1400	500	
21		KP121840015	1200	1800	400	
22		KP121850015	1200	1800	500	
23		KP121860015	1200	1800	600	
24		KP122040015	1200	2000	400	
25		KP122050015	1200	2000	500	
26		KP122060015	1200	2000	600	
27		KP122080015	1200	2000	800	
28	KP122260015	1200	2200	600		
29	整柜整装 Complete Enclosure (Full Assembled)	KP601650105	600	1600	500	包括: 箱体框架1套, 单开门1扇, 后板1块, 顶板1块, 运输吊环4个, 三段式底板1套, 安装板1块。  Includes: 1 Enclosure frame, 1 single door, 1 rear wall, 1 roof, 4 eye-bolt, 1 bottom, 1 mounting plate. RAL 7035
30		KP601850105	600	1800	500	
31		KP601860105	600	1800	600	
32		KP602040105	600	2000	400	
33		KP602050105	600	2000	500	
34		KP602060105	600	2000	600	
35		KP602080105	600	2000	800	
36		KP602260105	600	2200	600	
37		KP801450105	800	1400	500	
38		KP801650105	800	1600	500	
39		KP801850105	800	1800	500	
40		KP801860105	800	1800	600	
41		KP801880105	800	1800	800	
42		KP802050105	800	2000	500	
43		KP802060105	800	2000	600	
44		KP802080105	800	2000	800	
45		KP802260105	800	2200	600	
46		KP102050115	1000	2000	500	
47		KP102060115	1000	2000	600	
48		KP121450115	1200	1400	500	
49		KP121840115	1200	1800	400	
50		KP121850115	1200	1800	500	
51		KP121860115	1200	1800	600	
52		KP122040115	1200	2000	400	
53		KP122050115	1200	2000	500	
54		KP122060115	1200	2000	600	
55		KP122080115	1200	2000	800	
56	KP122260115	1200	2200	600		
57	侧板 Side Wall	KPSW1650005	SW	1400	500	包括: 侧板2块, 安装附件A 1套 (侧板固定件12个, ST6.3*18 螺钉12颗)  Includes: 2 side walls, 1 set of A-type fixture accessories ( 12 fixtures, 12 ST6.3x18 Phillip- head Screws).
58		KPSW1650005	SW	1600	500	
59		KPSW1840005	SW	1800	400	
60		KPSW1850005	SW	1800	500	
61		KPSW1860005	SW	1800	600	
62		KPSW1880005	SW	1800	800	
63		KPSW2040005	SW	2000	400	
64		KPSW2050005	SW	2000	500	
65		KPSW2060005	SW	2000	600	
66		KPSW2080005	SW	2000	800	
67	KPSW2260005	SW	2200	600		



KP系列订货规格表

List of specification of KP enclosures

\*可定制非标产品  
Nonstandard products are customizable

序号 No.	类别 Category	订货号 Order No.	宽 Width (mm)	高 Height (mm)	深 Depth (mm)	供货范围 Supply Includes
1	安装板 Mounting_Plate	KP6016MP005	600	1600	MP	包括: 安装板1块, 安装附件E 1套, 镀锌板  Includes: 1 mounting plate, 1 set E-type of fixture accessories, Zinc plated
2		KP6018MP005	600	1800	MP	
3		KP6020MP005	600	2000	MP	
4		KP6022MP005	600	2200	MP	
5		KP8014MP005	800	1400	MP	
6		KP8016MP005	800	1600	MP	
7		KP8018MP005	800	1800	MP	
8		KP8020MP005	800	2000	MP	
9		KP8022MP005	800	2200	MP	
10		KP1018MP005	1000	1800	MP	
11		KP1020MP005	1000	2000	MP	
12		KP1214MP005	1200	1400	MP	
13		KP1218MP005	1200	1800	MP	
14		KP1220MP005	1200	2000	MP	
15		KP1222MP005	1200	2200	MP	
16	门 Door	KP6016DS005	600	1600	DS	包括: 小型平面锁1把, 铰链3个, 锁杆1对, 锁挡块2个, 锁舌1片。  Includes: 1 small falt lock, 3 hing, 1 pair of lock rod, 2 lock hock, 1 lock plate.
17		KP6018DS005	600	1800	DS	
18		KP6020DS005	600	2000	DS	
19		KP6022DS005	600	2200	DS	
20		KP8014DS005	800	1400	DS	
21		KP8016DS005	800	1600	DS	
22		KP8018DS005	800	1800	DS	
23		KP8020DS005	800	2000	DS	
24		KP8022DS005	800	2200	DS	
25		KP1018DD005	1000	1800	DD	
26		KP1020DD005	1000	2000	DD	
27		KP1214DD005	1200	1400	DD	
28		KP1218DD005	1200	1800	DD	
29		KP1220DD005	1200	2000	DD	
30		KP1222DD005	1200	2200	DD	
31	后板 Rear Wall	KP6016RW005	600	1600	RW	包括: 后板1块, 安装附件C 1套(背板固定件6个 M6*10内六角螺丝6颗, M6*16螺丝6颗)。  Includes: 1 rear wall, 1 set of C-type fixture accessories ( 6 Real Plate Fixtures, 6 M6x10 AllenHead Screws, 6 M6x16 Phillip-headScrews).
32		KP6018RW005	600	1800	RW	
33		KP6020RW005	600	2000	RW	
34		KP6022RW005	600	2200	RW	
35		KP8014RW005	800	1400	RW	
36		KP8016RW005	800	1600	RW	
37		KP8018RW005	800	1800	RW	
38		KP8020RW005	800	2000	RW	
39		KP8022RW005	800	2200	RW	
40		KP1018RW005	1000	1800	RW	
41		KP1020RW005	1000	2000	RW	
42		KP1214RW005	1200	1400	RW	
43		KP1218RW005	1200	1800	RW	
44		KP1220RW005	1200	2000	RW	
45		KP1222RW005	1200	2200	RW	
46	前后框 Front/Rear Frame	KP6016FF005	600	1600	FF	包括: 前后框架2个 Includes: 2 frames
47		KP6018FF005	600	1800	FF	
48		KP6020FF005	600	2000	FF	
49		KP6022FF005	600	2200	FF	
50		KP8014FF005	800	1400	FF	
51		KP8016FF005	800	1600	FF	
52		KP8018FF005	800	1800	FF	
53		KP8020FF005	800	2000	FF	
54		KP8022FF005	800	2200	FF	
55		KP1018FF005	1000	1800	FF	
56		KP1020FF005	1000	2000	FF	
57		KP1214FF005	1200	1400	FF	
58		KP1218FF005	1200	1800	FF	
59		KP1220FF005	1200	2000	FF	
60		KP1222FF005	1200	2200	FF	
61	框架深度梁 Depth Beam	KPFD40005	FD	FD	400	包括: 框架深度梁4根, M5*20螺丝8颗。 Includes: 4 beams and 8 pieces of M5X20 screw.
62		KPFD50005	FD	FD	500	
63		KPFD60005	FD	FD	600	
64		KPFD80005	FD	FD	800	



材料 Material	SUS304 (其它材料型号可选) SUS304 (other material types are optional)
表面处理 Surface treatment	拉丝, 安装板则为镀锌 Wire drawing, and mounting plate is galvanized
防护等级 Protection	IP55 (符合IEC 60529) NAME 12 (Type12) IP55 (Acc to IEC 60529) NAME 12 (Type12)
标准配置 Standard configuration	前门、背板、安装板、柜体、密封条、门锁、侧板(可选件) Front door, back plate, mounting plate, cabinet body, sealing strip, door lock and side plate (optional)
钢板厚度 Plate thickness	框架: 九折型材1.5mm 门板: 2.0mm 背板、侧板: 1.5mm 安装板: 2.5mm Frame: nine-fold section 1.5mm Door plate: 2.0mm Back plate and side plate: 1.5mm Mounting plate: 2.5mm
认证证书 Certification	



限位器/铰链/加强方管  
Stopper/hinge/  
reinforced square pipe

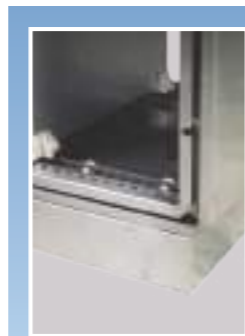

固定底座  
Fixing base



不锈钢三通连接件  
Stainless steel three-  
way connection  
element



KP不锈钢系列订货规格表

KP Stainless steel series order specification table

\*可定制非标产品  
Nonstandard products are customizable

序号 No.	类别 Category	订货号 Order No.	宽 Width (mm)	高 Height (mm)	深 Depth (mm)	供货范围 Supply Includes
1	整柜散装 Complete Enclosure (Flat Packing)	KP60165000S	600	1600	500	包括: 前后框2个, 框架深度梁4根, 单开门1扇, 后板1块, 顶板1块, 运输吊环4个, 三段式底板1套, 安装板1块。  Includes: 2 front/rear frames, 4 depth beams, 1 single door, 1 rear wall, 1 roof, 4 eye-bolt, 1 bottom, 1 mounting plate. RAL 7035
2		KP60185000S	600	1800	500	
3		KP60186000S	600	1800	600	
4		KP60204000S	600	2000	400	
5		KP60205000S	600	2000	500	
6		KP60206000S	600	2000	600	
7		KP60208000S	600	2000	800	
8		KP60226000S	600	2200	600	
9		KP80145000S	800	1400	500	
10		KP80165000S	800	1600	500	
11		KP80185000S	800	1800	500	
12		KP80186000S	800	1800	600	
13		KP80188000S	800	1800	800	
14		KP80205000S	800	2000	500	
15		KP80206000S	800	2000	600	
16		KP80208000S	800	2000	800	
17		KP80226000S	800	2200	600	
18		KP10205001S	1000	2000	500	包括: 前后框2个, 框架深度梁4根, 双开门1扇, 后板1块, 顶板1块, 运输吊环4个, 三段式底板1套, 安装板1块。  Includes: 2 front/rear frames, 4 depth beams, 1 double door, 1 rear wall, 1 roof, 4 eye-bolt, 1 bottom, 1 mounting plate. RAL 7035
19		KP10206001S	1000	2000	600	
20		KP12145001S	1200	1400	500	
21		KP12184001S	1200	1800	400	
22		KP12185001S	1200	1800	500	
23		KP12186001S	1200	1800	600	
24		KP12204001S	1200	2000	400	
25		KP12205001S	1200	2000	500	
26		KP12206001S	1200	2000	600	
27		KP12208001S	1200	2000	800	
28	KP12226001S	1200	2200	600		
29	整柜整装 Complete Enclosure (Full Assembled)	KP60165010S	600	1600	500	
30		KP60185010S	600	1800	500	
31		KP60186010S	600	1800	600	
32		KP60204010S	600	2000	400	
33		KP60205010S	600	2000	500	
34		KP60206010S	600	2000	600	
35		KP60208010S	600	2000	800	
36		KP60226010S	600	2200	600	
37		KP80145010S	800	1400	500	
38		KP80165010S	800	1600	500	
39		KP80185010S	800	1800	500	
40		KP80186010S	800	1800	600	
41		KP80188010S	800	1800	800	
42		KP80205010S	800	2000	500	
43		KP80206010S	800	2000	600	
44		KP80208010S	800	2000	800	
45		KP80226010S	800	2200	600	
46		KP10205011S	1000	2000	500	
47		KP10206011S	1000	2000	600	
48		KP12145011S	1200	1400	500	
49	KP12184011S	1200	1800	400		
50	KP12185011S	1200	1800	500		
51	KP12186011S	1200	1800	600		
52	KP12204011S	1200	2000	400		
53	KP12205011S	1200	2000	500		
54	KP12206011S	1200	2000	600		
55	KP12208011S	1200	2000	800		
56	KP12226011S	1200	2200	600		
57	侧板 Side Wall	KPSW165000S	SW	1400	500	包括: 侧板2块, 安装附件A 1套 (侧板固定件12个, ST6.3*18 螺钉12颗)  Includes: 2 side walls, 1 set of A-type fixture accessories ( 12 fixtures, 12 ST6.3x18 Phillip-head Screws).
58		KPSW165000S	SW	1600	500	
59		KPSW184000S	SW	1800	400	
60		KPSW185000S	SW	1800	500	
61		KPSW186000S	SW	1800	600	
62		KPSW188000S	SW	1800	800	
63		KPSW204000S	SW	2000	400	
64		KPSW205000S	SW	2000	500	
65		KPSW206000S	SW	2000	600	
66		KPSW208000S	SW	2000	800	
67	KPSW226000S	SW	2200	600		

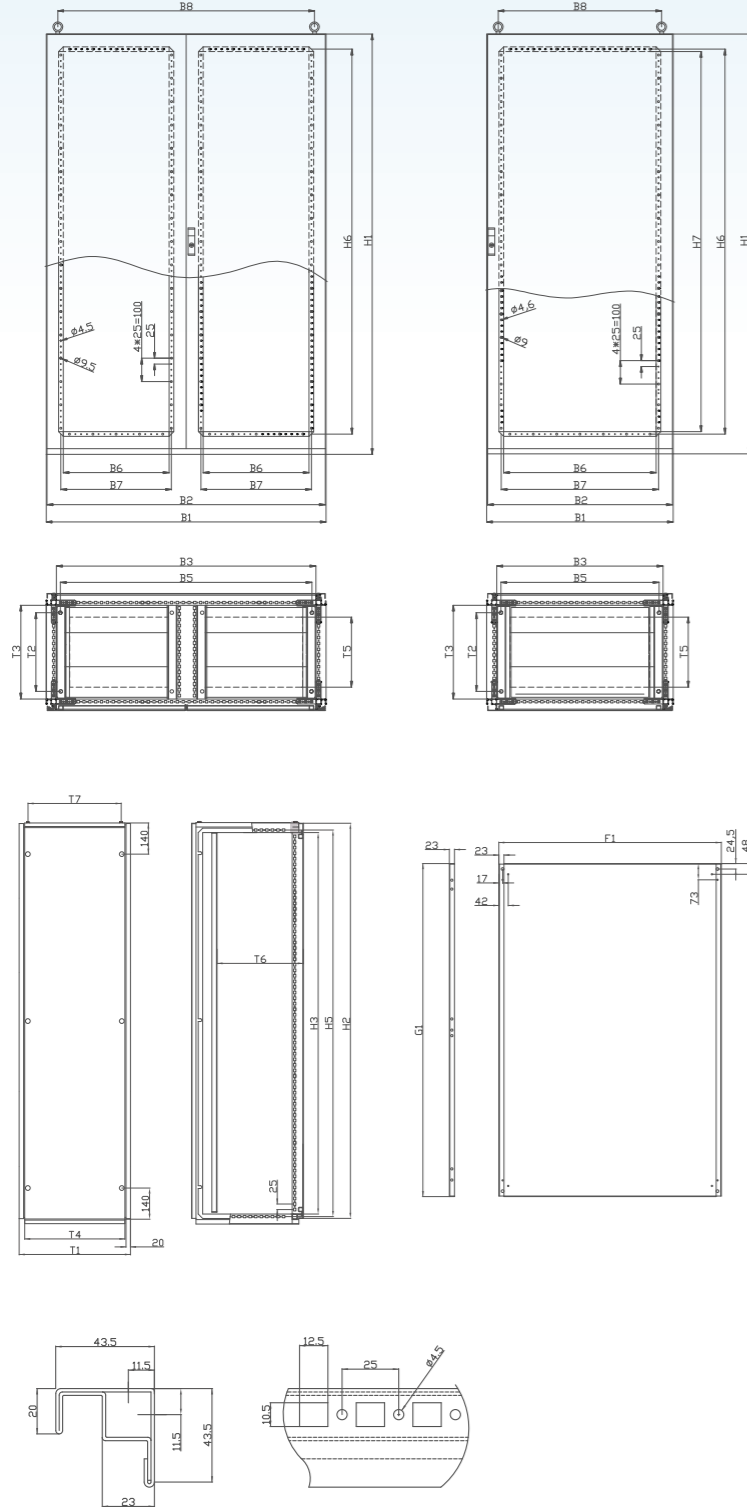

- B1: 总宽度  
(不含侧板, 框架外圈尺寸)
- B2: 门的宽度
- B3: 箱体框架内的净宽度
- B5: 柜体下纵梁与底板对应孔  
(无底座, 此孔与地面相连接)
- B6: 门板后部方管加强筋左右侧内档距离
- B7: 门板后部方管加强筋左右侧中心距离
- B8: 两个吊环之间的距离
- B9: 箱底开缝宽度
- T1: 总深度
- T2: 底板与地面固定物前后连接孔.
- T3: 底框内的净深度
- T4: 底框深度
- T5: 箱底开缝的深度
- T6: 安装板深度, 从149mm开始以每格25mm的距离进行调节
- T7: 两个吊环中心点之间的距离
- H1: 总高度
- H2: 门和后背板的高度
- H3: 箱底框架内的净高度
- H5: 框架上下横型材梁之间的高度
- H6: 门板后部方管加强筋上下侧中心距离
- H7: 门板后部方管加强筋上下侧内档距离

- F: 安装板的总宽度
- G: 安装板的总高度
- B1: Total width (Excluding the lateral plate, the outer frame size)
- B2: Door width
- B3: Net width of the cabinet inner frame
- B5: Corresponding hole of longitudinal beam beneath cabinet and bottom plate(Without base, this hole connected to the ground)
- B6: The left and right interior distance of the square tube reinforcing rib installation in the back of door plate
- B7: The left and right center distance of the square tube reinforcing rib in the back of door plate
- B8: The distance between the two rings
- B9: Cabinet bottom slit width
- T1: Total depth
- T2: The front and back connection holes for the fixation of the Bottom plate and ground
- T3: Net depth in the bottom frame
- T4: Depth of the bottom frame
- T5: Depth of the slit in the cabinet bottom
- T6: Mounting plate depth, the adjustment is from the beginning of the 149 mm in per 25 mm distance.
- T7: The distance between the center of the two rings
- H1: Total height
- H2: The height of the door and back plate
- H3: The net height in the frame of the cabinet bottom
- H5: The height of the upper and lower landscape Shaped beam of the frame
- H6: The left and right center distance of the square tube reinforcing rib in the back of door plate
- H7: The left and right interior distance of the square tube reinforcing rib in the back of door plate
- F: Mounting plate width
- G: Mounting plate height

\*B1: 宽度 ≥ 1200 时, 底部进线板结构分左右 2 部分。  
\*B1: ≥1200 width, the bottom line board structure at around 2 parts.

规格尺寸 Dimension			宽度 Width							高度 Height							深度 Depth							安装板 Mounting Plate	
宽 Width	高 Height	深 Depth	B1	B2	B3	B5	B6	B7	B8	B9	H1	H2	H3	H5	H6	H7	T1	T2	T3	T4	T5	T6	T7	F	G
600	1600	500	599	592	512	478	454	474	535	400	1600	1575	1512	1535	1450	1430	500	335	402	450	300	449	425	1496	498
600	1800	400	599	592	512	478	454	474	535	400	1800	1775	1712	1735	1650	1630	400	235	302	350	200	349	325	498	1696
600	1800	500	599	592	512	478	454	474	535	400	1800	1775	1712	1735	1650	1630	500	335	402	450	300	449	425	498	1696
600	1800	600	599	592	512	478	454	474	535	400	1800	1775	1712	1735	1650	1630	600	435	502	550	400	549	525	498	1696
600	2000	400	599	592	512	478	454	474	535	400	2000	1975	1912	1935	1850	1830	400	235	302	350	200	349	325	498	1896
600	2000	500	599	592	512	478	454	474	535	400	2000	1975	1912	1935	1850	1830	500	335	402	450	300	449	425	498	1896
600	2000	600	599	592	512	478	454	474	535	400	2000	1975	1912	1935	1850	1830	600	435	502	550	400	549	525	498	1896
600	2000	800	599	592	512	478	454	474	535	400	2000	1975	1912	1935	1850	1830	800	635	702	750	600	749	725	498	1896
600	2200	600	599	592	512	478	454	474	535	400	2200	2175	2112	2135	2050	2030	600	435	502	550	400	549	525	498	2096
800	1400	500	799	792	712	678	654	674	735	600	1400	1375	1312	1335	1250	1230	500	335	402	450	300	449	425	1296	698
800	1600	500	799	792	712	678	654	674	735	600	1600	1575	1512	1535	1450	1430	500	335	402	450	300	449	425	1496	698
800	1800	400	799	792	712	678	654	674	735	600	1800	1775	1712	1735	1650	1630	400	235	302	350	200	349	325	698	1696
800	1800	500	799	792	712	678	654	674	735	600	1800	1775	1712	1735	1650	1630	500	335	402	450	300	449	425	698	1696
800	1800	600	799	792	712	678	654	674	735	600	1800	1775	1712	1735	1650	1630	600	435	502	550	400	549	525	698	1696
800	2000	400	799	792	712	678	654	674	735	600	2000	1975	1912	1935	1850	1830	400	235	302	350	200	349	325	698	1896
800	2000	500	799	792	712	678	654	674	735	600	2000	1975	1912	1935	1850	1830	500	335	402	450	300	449	425	698	1896
800	2000	600	799	792	712	678	654	674	735	600	2000	1975	1912	1935	1850	1830	600	435	502	550	400	549	525	698	1896
800	2000	800	799	792	712	678	654	674	735	600	2000	1975	1912	1935	1850	1830	800	635	702	750	600	749	725	698	1896
800	2200	600	799	792	712	678	654	674	735	600	2200	2175	2112	2135	2050	2030	600	435	502	550	400	549	525	698	2096
1000	1800	400	999	992	912	878	854	874	935	800	1800	1775	1712	1735	1650	1630	400	235	302	350	200	349	325	898	1696
1000	2000	500	999	992	912	878	854	874	935	800	2000	1975	1912	1935	1850	1830	500	335	402	450	300	449	425	898	1896
1000	2000	600	999	992	912	878	854	874	935	800	2000	1975	1912	1935	1850	1830	600	435	502	550	400	549	525	898	1896
1200	1400	500	1199	1192	1112	1078	1054	1074	1135	1000	1400	1375	1312	1335	1250	1230	500	335	402	450	300	449	425	1296	1098
1200	1800	400	1199	1192	1112	1078	1054	1074	1135	1000	1800	1775	1712	1735	1650	1630	400	235	302	350	200	349	325	1098	1696
1200	1800	500	1199	1192	1112	1078	1054	1074	1135	1000	1800	1775	1712	1735	1650	1630	500	335	402	450	300	449	425	1098	1696
1200	1800	600	1199	1192	1112	1078	1054	1074	1135	1000	1800	1775	1712	1735	1650	1630	600	435	502	550	400	549	525	1098	1696
1200	2000	400	1199	1192	1112	1078	1054	1074	1135	1000	2000	1975	1912	1935	1850	1830	400	235	302	350	200	349	325	1098	1896
1200	2000	500	1199	1192	1112	1078	1054	1074	1135	1000	2000	1975	1912	1935	1850	1830	500	335	402	450	300	449	425	1098	1896
1200	2000	600	1199	1192	1112	1078	1054	1074	1135	1000	2000	1975	1912	1935	1850	1830	600	435	502	550	400	549	525	1098	1896
1200	2000	800	1199	1192	1112	1078	1054	1074	1135	1000	2000	1975	1912	1935	1850	1830	800	635	702	750	600	749	725	1098	1896
1200	2200	600	1199	1192	1112	1078	1054	1074	1135	1000	2200	2175	2112	2135	2050	2030	600	435	502	550	400	549	525	1098	2096



材料 Material	冷轧钢板 Cold-roll steel sheet
表面处理 Surface treatment	机柜磷化底涂处理，外部为粉末涂层，颜色可分RAL7032和RAL7035两种织纹，安装板则为镀锌 Cabinet is applied with etch primer and covered with powder coating on the outer side. Two color textures, RAL7032 and RAL7035, are available. The mounting plate is galvanized.
防护等级 Protection	IP55 (符合IEC 60529) NAME 12 (Type12) IP55 (Acc to IEC 60529) NAME 12 (Type12)
标准配置 Standard configuration	前门、背板、安装板、柜体、密封条、门锁、侧板(可选) Front door, back plate, mounting plate, cabinet body, sealing strip, door lock and side plate (optional)
钢板厚度 Plate thickness	框架：十六折型材1.5mm 门板：2.0mm 背板、侧板：1.5mm 安装板：2.5mm Frame: TS profile 1.5mm Door plate: 2.0mm Back plate and side plate: 1.5mm Mounting plate: 2.5mm
认证证书 Certification	



柜体的垂直剖面采用了十六折型材，不仅提供了两层安装平面而且将安装空间利用率提高了15%  
The 16-fold profile of the vertical sections is the key to an intelligent two-level concept, which not only provides a second mounting level as standard, but also offers up to 15% more installation space in the enclosure.



通过在框架和所有面板之间进行导电连接，机柜装配完成后，盖板、侧板、后板、顶盖将自动实现电势平衡。  
Potential equalisation for the gland plates, side panels, rear panel and roof is achieved automatically when the enclosure is assembled. That guarantees a conductive contact between the frame and all panel parts.



门铰链无需任何机械改装即可切换到另一侧  
The door hinge can be switched to the other side with no mechanical modification.

### 产品特点 Features of Products

- 由于完全对称的框架截面，使用附件时具有完全的灵活性，宽度和深度的附件相同
- 四面都可以并柜
- 门铰链可以轻松互换到另外的一侧，无需再加工。
- 通过所有外壳面板和法兰盘组件实现自动电位均衡
- 具有高达1500kg的高承载能力
- 安装板能简单快速安装。固定滑块可以在侧框内自由安装和拆卸。

- Full flexibility with the use of accessories, thanks to a fully symmetrical frame section. With identical accessories for the width and depth
- Bayable on all sides
- Door hinge is easily swapped to the opposite side without machining
- Automatic potential equalisation via the assembly components with all enclosure panels and gland plates
- Enclosure has a high load-bearing capacity of up to 1500 kg
- Simple, fast assembly of the mounting plate. Slide rails may be removed and installed in the side frame section

### 框架安装 Frame mounting

#### 安装工具

M5梅花批头、手电钻

将四根纵梁如图方向插入前后框架，使用梅花槽沉头三角锁紧螺钉M5×20对孔固定。

#### Installation tool

1. M5 Torx screwdriver bit and hand drill

2. Insert the four longitudinal beams into the front and rear frames in the orientation shown in the diagram, and secure them through the aligned holes using M5×20 countersunk Torx triangular locking screws.

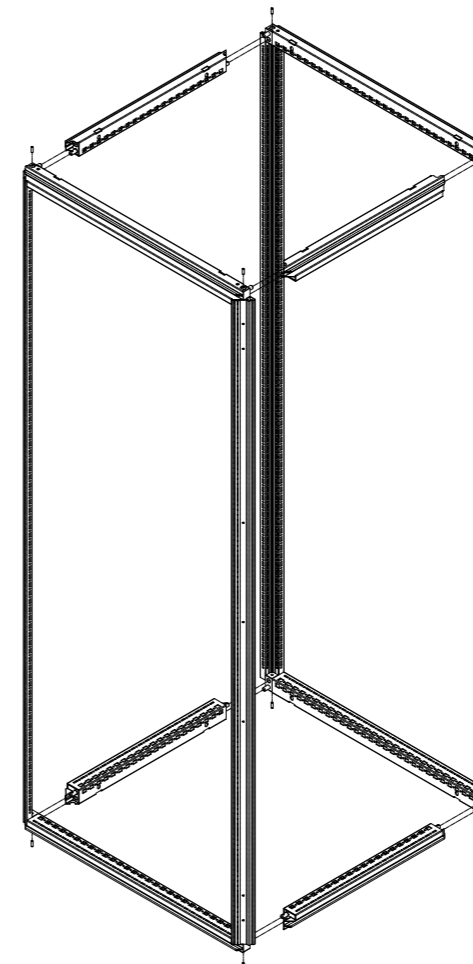

项次 Item number	描述 Description	数量 Quantity
1	梅花槽沉头三角锁紧螺钉M5×20	8个
1	M5×20 Multi-tooth Head taping screw	8 pcs

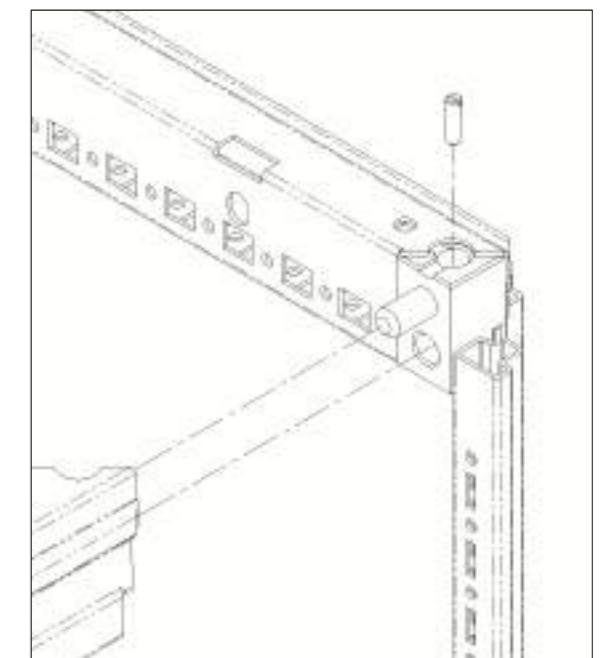



KT系列常规订货规格表

LIST OF CONVENTIONAL SPECIFICATIONS OF KT ENCLOSURES

序号 No.	类别 Category	订货号 Order No.	宽 Width (mm)	高 Height (mm)	深 Depth (mm)	供货范围 Supply Includes
1	整柜散装 Complete Enclosure (Flat Packing)	KT601650005	600	1600	500	包括: 前后框2个, 框架深度梁4根, 单开门1扇, 后板1块, 顶板1块, 运输吊环4个, 三段式底板1套, 安装板1块。  Includes: 2 front/rear frames, 4 depth beams, 1 single door, 1 rear wall, 1 roof, 4 eye-bolt, 1 bottom, 1 mounting plate. RAL 7035
2		KT601850005	600	1800	500	
3		KT601860005	600	1800	600	
4		KT602040005	600	2000	400	
5		KT602050005	600	2000	500	
6		KT602060005	600	2000	600	
7		KT602080005	600	2000	800	
8		KT802260005	600	2200	600	
9		KT801450005	800	1400	500	
10		KT801650005	800	1600	500	
11		KT801850005	800	1800	500	
12		KT801860005	800	1800	600	
13		KT801880005	800	1800	800	
14		KT802050005	800	2000	500	
15		KT802060005	800	2000	600	
16		KT802080005	800	2000	800	
17		KT802260005	800	2200	600	
18		KT102050015	1000	2000	500	
19		KT102060015	1000	2000	600	
20		KT121450015	1200	1400	500	
21		KT121840015	1200	1800	400	
22		KT121850015	1200	1800	500	
23		KT121860015	1200	1800	600	
24		KT122040015	1200	2000	400	
25		KT122050015	1200	2000	500	
26		KT122060015	1200	2000	600	
27		KT122080015	1200	2000	800	
28	KT122260015	1200	2200	600		
29	整柜整装 Complete Enclosure (Full Assembled)	KT601650105	600	1600	500	包括: 箱体框架1套, 单开门1扇, 后板1块, 顶板1块, 运输吊环4个, 三段式底板1套, 安装板1块。  Includes: 1 Enclosure frame, 1 single door, 1 rear wall, 1 roof, 4 eye-bolt, 1 bottom, 1 mounting plate. RAL 7035
30		KT601850105	600	1800	500	
31		KT601860105	600	1800	600	
32		KT602040105	600	2000	400	
33		KT602050105	600	2000	500	
34		KT602060105	600	2000	600	
35		KT602080105	600	2000	800	
36		KT602260105	600	2200	600	
37		KT801450105	800	1400	500	
38		KT801650105	800	1600	500	
39		KT801850105	800	1800	500	
40		KT801860105	800	1800	600	
41		KT801880105	800	1800	800	
42		KT802050105	800	2000	500	
43		KT802060105	800	2000	600	
44		KT802080105	800	2000	800	
45		KT802260105	800	2200	600	
46		KT102050115	1000	2000	500	
47		KT102060115	1000	2000	600	
48		KT121450115	1200	1400	500	
49		KT121840115	1200	1800	400	
50		KT121850115	1200	1800	500	
51		KT121860115	1200	1800	600	
52		KT122040115	1200	2000	400	
53		KT122050115	1200	2000	500	
54		KT122060115	1200	2000	600	
55		KT122080115	1200	2000	800	
56	KT122260115	1200	2200	600		
57	侧板 Side Wall	KTSW1650005	SW	1400	500	包括: 侧板2块, 安装附件A 1套 (侧板固定件12个, ST6.3*18 螺钉12颗)  Includes: 2 side walls, 1 set of A-type fixture accessories ( 12 fixtures, 12 ST6.3x18 Phillip- head Screws).
58		KTSW1650005	SW	1600	500	
59		KTSW1840005	SW	1800	400	
60		KTSW1850005	SW	1800	500	
61		KTSW1860005	SW	1800	600	
62		KTSW1880005	SW	1800	800	
63		KTSW2040005	SW	2000	400	
64		KTSW2050005	SW	2000	500	
65		KTSW2060005	SW	2000	600	
66		KTSW2080005	SW	2000	800	
67	KTSW2260005	SW	2200	600		



KT系列常规订货规格表

LIST OF CONVENTIONAL SPECIFICATIONS OF KT ENCLOSURES

序号 No.	类别 Category	订货号 Order No.	宽 Width (mm)	高 Height (mm)	深 Depth (mm)	供货范围 Supply Includes
1	安装板 Mounting_Plate	KT6016MP005	600	1600	MP	包括: 安装板1块, 安装附件E 1套, 镀锌板  Includes: 1 mounting plate, 1 set E-type of fixture accessories, Zinc plated
2		KT6018MP005	600	1800	MP	
3		KT6020MP005	600	2000	MP	
4		KT6022MP005	600	2200	MP	
5		KT8014MP005	800	1400	MP	
6		KT8016MP005	800	1600	MP	
7		KT8018MP005	800	1800	MP	
8		KT8020MP005	800	2000	MP	
9		KT8022MP005	800	2200	MP	
10		KT1018MP005	1000	1800	MP	
11		KT1020MP005	1000	2000	MP	
12		KT1214MP005	1200	1400	MP	
13		KT1218MP005	1200	1800	MP	
14		KT1220MP005	1200	2000	MP	
15		KT1222MP005	1200	2200	MP	
16	门 Door	KT6016DS005	600	1600	DS	包括: 小型平面锁1把, 铰链3个, 锁杆1对, 锁挡块2个, 锁舌1片。  Includes: 1 small falt lock, 3 hing, 1 pair of lock rod, 2 lock hock, 1 lock plate.
17		KT6018DS005	600	1800	DS	
18		KT6020DS005	600	2000	DS	
19		KT6022DS005	600	2200	DS	
20		KT8014DS005	800	1400	DS	
21		KT8016DS005	800	1600	DS	
22		KT8018DS005	800	1800	DS	
23		KT8020DS005	800	2000	DS	
24		KT8022DS005	800	2200	DS	
25		KT1018DD005	1000	1800	DD	
26		KT1020DD005	1000	2000	DD	
27		KT1214DD005	1200	1400	DD	
28		KT1218DD005	1200	1800	DD	
29		KT1220DD005	1200	2000	DD	
30		KT1222DD005	1200	2200	DD	
31	后板 Rear Wall	KT6016RW005	600	1600	RW	包括: 后板1块, 安装附件C 1套(背板固定件6个 M6*10内六角螺丝6颗, M6*16螺丝6颗)。  Includes: 1 rear wall, 1 set of C-type fixture accessories ( 6 Real Plate Fixtures, 6 M6x10 AllenHead Screws, 6 M6x16 Phillip-headScrews).
32		KT6018RW005	600	1800	RW	
33		KT6020RW005	600	2000	RW	
34		KT6022RW005	600	2200	RW	
35		KT8014RW005	800	1400	RW	
36		KT8016RW005	800	1600	RW	
37		KT8018RW005	800	1800	RW	
38		KT8020RW005	800	2000	RW	
39		KT8022RW005	800	2200	RW	
40		KT1018RW005	1000	1800	RW	
41		KT1020RW005	1000	2000	RW	
42		KT1214RW005	1200	1400	RW	
43		KT1218RW005	1200	1800	RW	
44		KT1220RW005	1200	2000	RW	
45		KT1222RW005	1200	2200	RW	
46	前后框 Front/Rear Frame	KT6016FF005	600	1600	FF	包括: 前后框架2个 Includes: 2 frames
47		KT6018FF005	600	1800	FF	
48		KT6020FF005	600	2000	FF	
49		KT6022FF005	600	2200	FF	
50		KT8014FF005	800	1400	FF	
51		KT8016FF005	800	1600	FF	
52		KT8018FF005	800	1800	FF	
53		KT8020FF005	800	2000	FF	
54		KT8022FF005	800	2200	FF	
55		KT1018FF005	1000	1800	FF	
56		KT1020FF005	1000	2000	FF	
57		KT1214FF005	1200	1400	FF	
58		KT1218FF005	1200	1800	FF	
59		KT1220FF005	1200	2000	FF	
60		KT1222FF005	1200	2200	FF	
61	框架深度梁 Depth Beam	KTFDFD40005	FD	FD	400	包括: 框架深度梁4根, M5*20螺丝8颗。 Includes: 4 beams and 8 pieces of M5X20 screw.
62		KTFDFD50005	FD	FD	500	
63		KTFDFD60005	FD	FD	600	
64		KTFDFD80005	FD	FD	800	

KT系列尺寸规格表  
KT series dimension table

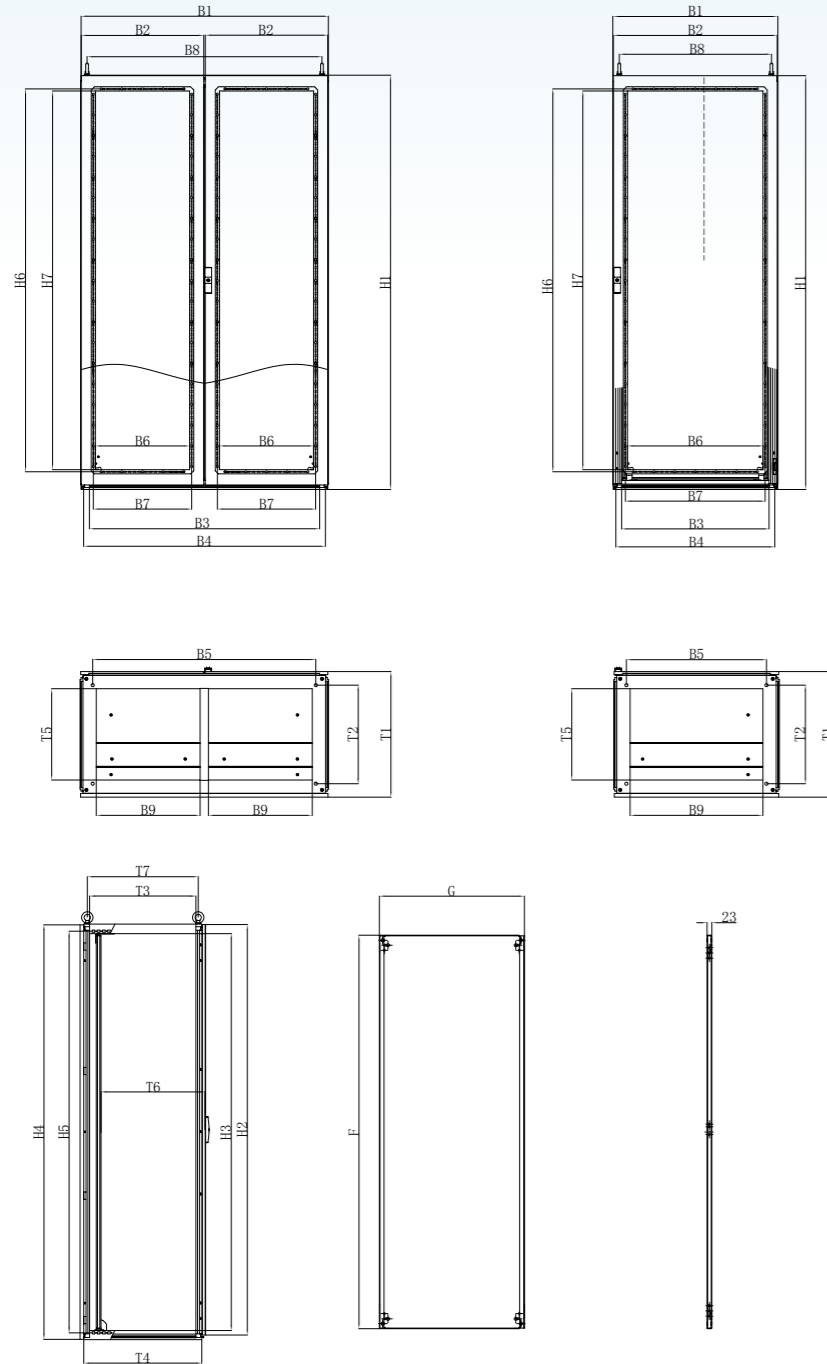

宽度 (B系列)  
 B1 总宽不含侧板  
 B2 门宽  
 B3 框架宽度开档宽度  
 B4 底框宽度  
 B5 底框固定孔宽度  
 B6 门加强筋宽度开档尺寸  
 B7 门加强筋中心距  
 B8 M12固定孔宽度尺寸  
 B9 底框开孔宽度尺寸

高度 (H系列)  
 H1 总高不含吊环  
 H2 门高  
 H3 框架高度度开档宽度  
 H4 后板高度  
 H5 上下水平型材固定孔中心距  
 H6 门加强筋中心距  
 H7 门加强筋高度开档尺寸

深度 (T系列)  
 T1 总深不含锁面高度  
 T2 底框固定孔深度  
 T3 框架深度度开档宽度  
 T4 底框深度  
 T5 底框开孔深度度尺寸  
 T6 安装板深度到门内表面  
 T7 M12固定孔深度度尺寸

其它尺寸  
 F 安装板总高  
 G 安装板总宽

Width (B Series):  
 B1 Overall width (excluding side panels)  
 B2 Door width  
 B3 Frame width / Opening width  
 B4 Base frame width  
 B5 Base frame fixing hole width  
 B6 Door reinforcement rib opening width  
 B7 Door reinforcement rib center distance  
 B8 M12 fixing hole width  
 B9 Base frame opening width

Height (H Series):  
 H1 Overall height (excluding lifting lugs)  
 H2 Door height  
 H3 Frame height / Opening width  
 H4 Rear panel height  
 H5 Upper & lower horizontal profile fixing hole center distance  
 H6 Door reinforcement rib center distance  
 H7 Door reinforcement rib opening height

Depth (T Series):  
 T1 Overall depth (excluding lock face height)  
 T2 Base frame fixing hole depth  
 T3 Frame depth / Opening width  
 T4 Base frame depth  
 T5 Base frame opening depth  
 T6 Mounting plate depth (to inner door surface)  
 T7 M12 fixing hole depth

Other Dimensions:  
 F Mounting plate total height  
 G Mounting plate total width

规格尺寸 Dimension			宽度 Width								高度 Height					深度 Depth						安装板 Mounting Plate					
宽 Width	高 Height	深 Depth	B1	B2	B3	B4	B5	B6	B7	B8	B9	H1	H2	H3	H4	H5	H6	H7	T1	T2	T3	T4	T5	T6	T7	F	G
600	1800	400	597	592	512	568	475	455	475	535	440	1800	1777.5	1712	1797	1735	1750	1630	405	275	312	368	240	126.5-356.5	335	1696	499
600	1800	500	597	592	512	568	475	455	475	535	440	1800	1777.5	1712	1797	1735	1750	1630	505	375	412	468	340	126.5-456.5	435	1696	499
600	1800	600	597	592	512	568	475	455	475	535	440	1800	1777.5	1712	1797	1735	1750	1630	605	475	512	568	440	126.5-556.5	535	1696	499
600	2000	400	597	592	512	568	475	455	475	535	440	2000	1977.5	1912	1997	1935	1850	1830	405	275	312	368	240	126.5-356.5	335	1896	499
600	2000	500	597	592	512	568	475	455	475	535	440	2000	1977.5	1912	1997	1935	1850	1830	505	375	412	468	340	126.5-456.5	435	1896	499
600	2000	600	597	592	512	568	475	455	475	535	440	2000	1977.5	1912	1997	1935	1850	1830	605	475	512	568	440	126.5-556.5	535	1896	499
600	2000	800	597	592	512	568	475	455	475	535	440	2000	1977.5	1912	1997	1935	1850	1830	805	675	712	768	640	126.5-756.6	735	1896	499
600	2200	600	597	592	512	568	475	455	475	535	440	2200	2177.5	2112	2197	2135	2050	2030	605	475	512	568	440	126.5-556.5	535	2096	499
800	1800	400	797	792	712	768	675	655	675	735	640	1800	1777.5	1712	1797	1735	1750	1630	405	275	312	368	240	126.5-356.5	335	1696	699
800	1800	500	797	792	712	768	675	655	675	735	640	1800	1777.5	1712	1797	1735	1750	1630	505	375	412	468	340	126.5-456.5	435	1696	699
800	1800	600	797	792	712	768	675	655	675	735	640	1800	1777.5	1712	1797	1735	1750	1630	605	475	512	568	440	126.5-556.5	535	1696	699
800	2000	400	797	792	712	768	675	655	675	735	640	2000	1977.5	1912	1997	1935	1850	1830	405	275	312	368	240	126.5-356.5	335	1896	699
800	2000	500	797	792	712	768	675	655	675	735	640	2000	1977.5	1912	1997	1935	1850	1830	505	375	412	468	340	126.5-456.5	435	1896	699
800	2000	600	797	792	712	768	675	655	675	735	640	2000	1977.5	1912	1997	1935	1850	1830	605	475	512	568	440	126.5-556.5	535	1896	699
800	2000	800	797	792	712	768	675	655	675	735	640	2000	1977.5	1912	1997	1935	1850	1830	805	675	712	768	640	126.5-756.6	735	1896	699
800	2200	600	797	792	712	768	675	655	675	735	640	2200	2177.5	2112	2197	2135	2050	2030	605	475	512	568	440	126.5-556.5	535	2096	699
1000	1800	400	997	492	912	968	875	355	375	935	400	1800	1777.5	1712	1797	1735	1750	1630	405	275	312	368	240	126.5-356.5	335	1896	899
1000	2000	500	997	492	912	968	875	355	375	935	400	2000	1977.5	1912	1997	1935	1850	1830	505	375	412	468	340	126.5-456.5	435	2096	899
1000	2000	600	997	492	912	968	875	355	375	935	400	2000	1977.5	1912	1997	1935	1850	1830	605	475	512	568	440	126.5-556.5	535	2096	899
1200	1800	400	1197	592	1112	1168	1075	455	475	1135	500	1800	1777.5	1712	1797	1735	1750	1630	405	275	312	368	240	126.5-356.5	335	1696	1099
1200	1800	500	1197	592	1112	1168	1075	455	475	1135	500	1800	1777.5	1712	1797	1735	1750	1630	505	375	412	468	340	126.5-456.5	435	1696	1099
1200	1800	600	1197	592	1112	1168	1075	455	475	1135	500	1800	1777.5	1712	1797	1735	1750	1630	605	475	512	568	440	126.5-556.5	535	1696	1099
1200	2000	400	1197	592	1112	1168	1075	455	475	1135	500	2000	1977.5	1912	1997	1935	1850	1830	405	275	312	368	240	126.5-356.5	335	1896	1099
1200	2000	500	1197	592	1112	1168	1075	455	475	1135	500	2000	1977.5	1912	1997	1935	1850	1830	505	375	412	468	340	126.5-456.5	435	1896	1099
1200	2000	600	1197	592	1112	1168	1075	455	475	1135	500	2000	1977.5	1912	1997	1935	1850	1830	605	475	512	568	440	126.5-556.5	535	1896	1099
1200	2000	800	1197	592	1112	1168	1075	455	475	1135	500	2000	1977.5	1912	1997	1935	1850	1830	805	675	712	768	640	126.5-756.6	735	1896	1099
1200	2200	600	1197	592	1112	1168	1075	455	475	1135	500	2200	2177.5	2112	2197	2135	2050	2030	605	475	512	568	440	126.5-556.5	535	2096	1099



产品特点 Features of Products

- 预装有角连接件的前后底座部件对某一所选定宽度始终是相同的。
- 根据相应的机柜深度和所希望的底座配置选取侧面护板。通过模块化方案能够在投资成本和功能方面具有特别的优势。
- 机柜上的安装可十分便捷舒适地从外部进行。底座内部空间为电缆管理的安装平面提供了多种多样的可能性。

- The base/plinth components at the front and rear, pre-configured with corner pieces, are always the same for the chosen width.
- Only the side trim panels are selected according to the enclosure depth and the required base/plinth configuration. The modular concept produces exceptional advantages in terms of cost and function.
- Mounting on the enclosure is conveniently carried out from the outside. Diverse mounting levels inside the base/plinth offers many opportunities for cable management.

底座 高度 Base/plinth height	基本形状 Basic form	电缆导引的方案 Cable entry options				
100 mm				并柜底座的加固 Stabilisation of bayed base/plinths		
200 mm						

订货规格表  
Order specifications table

序号 No.	类别 Category	KP订货号 Order No.	KT订货号 Order No.	宽 Width (mm)	高 Height (mm)	深 Depth (mm)	描述 Description
1	底座前后 Base / Plinth For Front and Rear	KP6010BF00J	KT6010BF00J	600	100	BF	包括：4个底座部件，4个封闭罩，4颗螺钉和用于在机柜上安装的插入式螺母，RAL9005  Includes: 4base/plinth components, 4 cover caps, 4 screws and cage nuts M12 for mounting on the enclosure, RAL9005
2		KP8010BF00J	KT8010BF00J	800	100	BF	
3		KP1010BF00J	KT1010BF00J	1000	100	BF	
4		KP1210BF00J	KT1210BF00J	1200	100	BF	
5		KP6020BF00J	KT6020BF00J	600	200	BF	
6		KP8020BF00J	KT8020BF00J	800	200	BF	
7		KP1020BF00J	KT1020BF00J	1000	200	BF	
8		KP1220BF00J	KT1220BF00J	1200	200	BF	
9	底座侧板 Base / Plinth trim for side	KPBL104000J	KTBL104000J	BL	100	400	包括：侧面护板2块，安装附件1套。RAL9005  Includes: 2 left/right plates, 1 set of fixture accessories. RAL9005
10		KPBL105000J	KTBL105000J	BL	100	500	
11		KPBL106000J	KTBL106000J	BL	100	600	
12		KPBL108000J	KTBL108000J	BL	100	800	
13		KPBL204000J	KTBL204000J	BL	200	400	
14		KPBL205000J	KTBL205000J	BL	200	500	
15		KPBL206000J	KTBL206000J	BL	200	600	
16		KPBL208000J	KTBL208000J	BL	200	800	

# 配件 Accessory



KP33000100Z  
外并柜六角钢  
Baying kit



KP33000200Z  
角并柜件  
Angular baying brackets



KP33000300Z  
并柜吊环  
Combination angle



KT33000400Z  
并柜连接件  
Baying connectors



KP33000500Z  
内并柜件  
Baying brackets



KT33000600Z  
U形并柜件  
U shape baying brackets



KP33000700J  
19英寸盲板, 1U  
1 U Blank panel, 19"



KP33000800Z  
门限位  
Door stay



KP33000900Y  
塑料图纸盒  
Plastic wiring plan pocket

## KP并联柜并柜配件包 KPBG-0001

6\*外并柜六角  
2\*并柜吊环  
4\*角并柜件  
4\*内并柜件  
6米密封条  
配套螺丝螺母

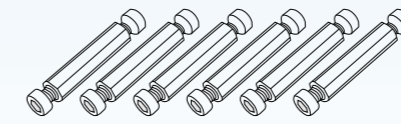

6\*外并柜六角钢 Baying kit

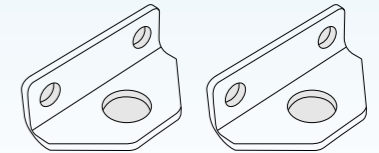

2\*并柜吊环 Combination angle

6\*Baying kit  
2\*Combination angle  
4\*Angular baying  
brackets  
4\*Baying brackets  
10 meters sealing strip  
Screws and nuts

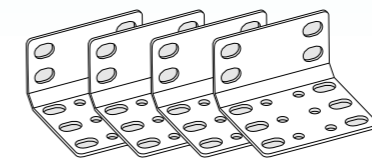

4\*角并柜件 Angular baying brackets

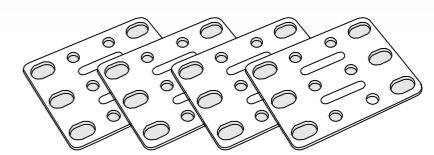

4\*内并柜件 Baying brackets

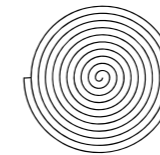

10米密封条 10 meters sealing strip

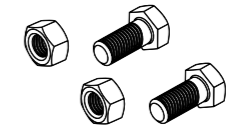

配套螺丝螺母 Screws and nuts

每两台并柜需要一套配件包 Each pair of parallel cabinets requires one set of accessories.

## KT并联柜并柜配件包 KTBG-0001

4\*角并柜件  
2\*并柜吊环  
4\*并柜连接件  
4\*内并柜件  
6米密封条  
配套螺丝螺母

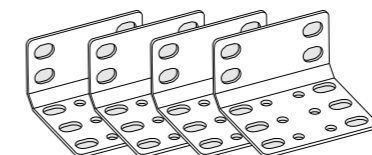

4\*角并柜件 Angular baying brackets

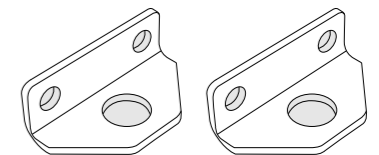

2\*并柜吊环 Combination angle

4\*Angular baying  
brackets  
2\*Combination angle  
4\*Baying connectors  
4\*Baying brackets  
6 meters sealing strip  
Screws and nuts

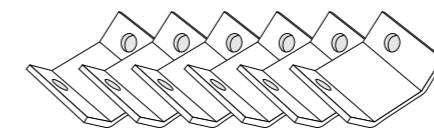

6\*并柜连接件 Baying connectors

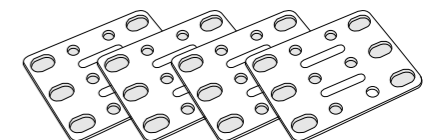

4\*内并柜件 Baying brackets

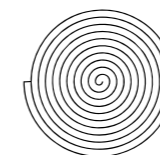

6米密封条 6 meters sealing strip

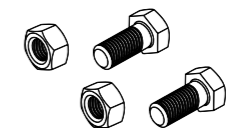

配套螺丝螺母 Screws and nuts

每两台并柜需要一套配件包 Each pair of parallel cabinets requires one set of accessories.