



Please read this document carefully before using this product. The guarantee will be invalidated if the device is damaged by not following instructions detailed in the manual. The company shall not be responsible for any damage or losses however caused, which may be experienced as a result of the installation or use of this product.

ENDA EU4430 PID UNIVERSAL CONTROLLER

Thank you for choosing ENDA EU4430 Universal Controller Devices.

- ▶ 48x48mm sized.
- ▶ Dual setpoint value can be selected.
- ▶ PT100 ,J, K, L, T, S, R sensor (thermocouple) types can be selected.
- ▶ 0-20mA, 4-20mA, 0-10V, 2-10V, 0-25mV and 0-50mV input selections.
- ▶ Auto calculation for PID parameters (SELF TUNE).

Self tune for automatic PID calculation or manually enter PID parameters if known.

- ▶ Three different feature can be assigned to digital input.
- ▶ Three different feature can be assigned to F function key.
- ▶ Soft-Start feature.
- ▶ Analogue, SSR or Relay Output Control selection.
- ▶ 0-20mA and 4-20mA Analogue Output Control selection.
- ▶ A1 Relay output programmable as primary Alarm or PID Cooling Control output.
- ▶ C/A2 Relay output can be used as secondary Alarm or Temperature Control output.
- ▶ Heating/Cooling control selection.
- ▶ Zero point input shift.
- ▶ In case of sensor failure, periodically, auto-periodically running or relay state can be selected.
- ▶ RS485 Modbus RTU communication protocol feature (Specify at order).
- ▶ CE marked according to European Norms.



RoHS
Compliant



Order Code : EU4430 - -

1 - Supply Voltage 230VAC...90 - 250V AC 24VAC...24V AC SM.....9-30V DC / 7-24V AC	2 - Modbus (Optional) RS..... RS-485 Modbus Available (Optional / Specify at order). Blank.... N/A
--	---

⚠ Please see EU4430 Modbus Address Map and Connection Diagram Guide for Modbus feature.

Input Type	Scale Range	Accuracy	
	°C	°F	
PT100 Resistance Thermometer EN 60751	-199.9...600.0 °C	-199.9...999.9 °F	± 0,2% (for full scale) ± 1 digit
PT100 Resistance Thermometer EN 60751	-200...600 °C	-328....1112 °F	± 0,2% (for full scale) ± 1 digit
J (Fe-CuNi) Thermocouple EN 60584	-30.0....600.0 °C	-22.0....999.9 °F	± 0,5% (for full scale) ± 1 digit
J (Fe-CuNi) Thermocouple EN 60584	-30....600°C	-22....1112 °F	± 0,5% (for full scale) ± 1 digit
K (NiCr-Ni) Thermocouple EN 60584	-30.0....999.9 °C	-22.0....999.9 °F	± 0,5% (for full scale) ± 1 digit
K (NiCr-Ni) Thermocouple EN 60584	-30....1300°C	-22....2372 °F	± 0,5% (for full scale) ± 1 digit
L (Fe-CuNi) Thermocouple DIN 43710	-30.0....600.0 °C	-22.0....999.9 °F	± 0,5% (for full scale) ± 1 digit
L (Fe-CuNi) Thermocouple DIN 43710	-30....600°C	-22....1112 °F	± 0,5% (for full scale) ± 1 digit
T (Cu-CuNi) Thermocouple EN 60584	-30.0....400.0 °C	-22.0....752.0 °F	± 0,5% (for full scale) ± 1 digit
T (Cu-CuNi) Thermocouple EN 60584	-30....400°C	-22....752 °F	± 0,5% (for full scale) ± 1 digit
S (Pt10Rh-Pt) Thermocouple EN 60584	-40...1700°C	-40....3092 °F	± 0,5% (for full scale) ± 1 digit
R (Pt13Rh-Pt) Thermocouple EN 60584	-40...1700°C	-40....3092 °F	± 0,5% (for full scale) ± 1 digit
0-20mA input	-1999...+9999 (max. scale range 10000)		± 0,2% (for full scale) ± 1 digit
4-20mA input	-1999...+9999 (max. scale range 10000)		± 0,2% (for full scale) ± 1 digit
0-10V input	-1999...+9999 (max. scale range 10000)		± 0,2% (for full scale) ± 1 digit
2-10V input	-1999...+9999 (max. scale range 10000)		± 0,2% (for full scale) ± 1 digit
0-25mV input	-1999...+9999 (max. scale range 10000)		± 0,2% (for full scale) ± 1 digit
0-50mV input	-1999...+9999 (max. scale range 10000)		± 0,2% (for full scale) ± 1 digit

ENVIRONMENTAL CONDITIONS

Ambient/storage temperature	0 ... +50°C/-25 ... +70°C
Max. Relative humidity	Relative humidity 80% for temperatures up to 31°C decreasing linearly to 50% relative humidity at 40°C.
Rated pollution degree	According to EN 60529; Front panel : IP65, Rear panel : IP20
Height	Max. 2000m

⚠ KEEP AWAY device from exposed to corrosive, volatile and flammable gases or liquids and DO NOT USE the device in similar hazardous locations.

ELECTRICAL CHARACTERISTICS

Supply	90-250V AC 50/60Hz, 24V AC ±%10 50/60Hz or 9-30VDC / 7-24VAC ±%10 SMPS
Power consumption	Max. 5VA
Wiring	Power screw-terminal connections: 2.5mm ² , Signal screw-terminal connections: 1,5mm ² .
Line resistance	Max. 100 Ohm
Data retention	EEPROM (minimum 10 years)
EMC	EN 61326-1: 2013 (Performance criterion B satisfied for EN 61000-4-3 standard).
Safety requirements	EN 61010-1: 2010 (Pollution degree 2, overvoltage category II)

OUTPUTS

C/A2 Output	Relay : 250V AC, 8A (for resistive load), NO+NC (Control or Alarm2 Output selection).
A1 Output	Relay : 250V AC, 8A (for resistive load), NO (Alarm1 and Cooling Control Output selection).
ANL/SSR Output	Max. SSR Output ; 0-20mA, 4-20mA, 24V 20mA. Max. load resistance ; 600 Ohm (12 bit 0.2% accuracy).
Life expectancy for relay	Without load 30.000.000 switching; 250V AC, 8A (resistive load) 300.000 switching.

CONTROL

Control type	Single Setpoint and Alarm Control.
Control algorithm	On-Off / P, PI, PD, PID (selection).
A/D converter	14 bit.
Sampling time	Min. 100ms.
Proportional band	Can be adjusted between %0.0 and %100.0 . If Pb=%0.0 , ON-OFF control is selected.
Control period	Can be adjusted between 1 and 125secs.
Hysteresis	Can be adjusted between 1 and 50°C/F.
Output power	Setpoint value ratio can be adjusted between %0 and %100 .

HOUSING

Housing type	Suitable for flush-panel mounting according to DIN 43 700.
Dimensions	W48xH48xD87mm
Weight	Approx. 250g
Enclosure material	Self extinguishing plastics

⚠ Avoid any liquid contact when the device is switched on.
DO NOT clean the device with solvent (thinner, gasoline, acid etc.) and / or abrasive cleaning agents.



SISEL MÜHENDİSLİK ELEKTRONİK SAN. VE TİC. A.Ş.
Sarıfili Mah. Barbaros Cad. No:18 Y.Dudullu 34775
ÜMRANİYE/İSTANBUL-TÜRKİYE
Tel : +90 216 499 46 64 Pbx. Fax : +90 216 365 74 01
url : www.enda.com.tr



DIMENSIONS

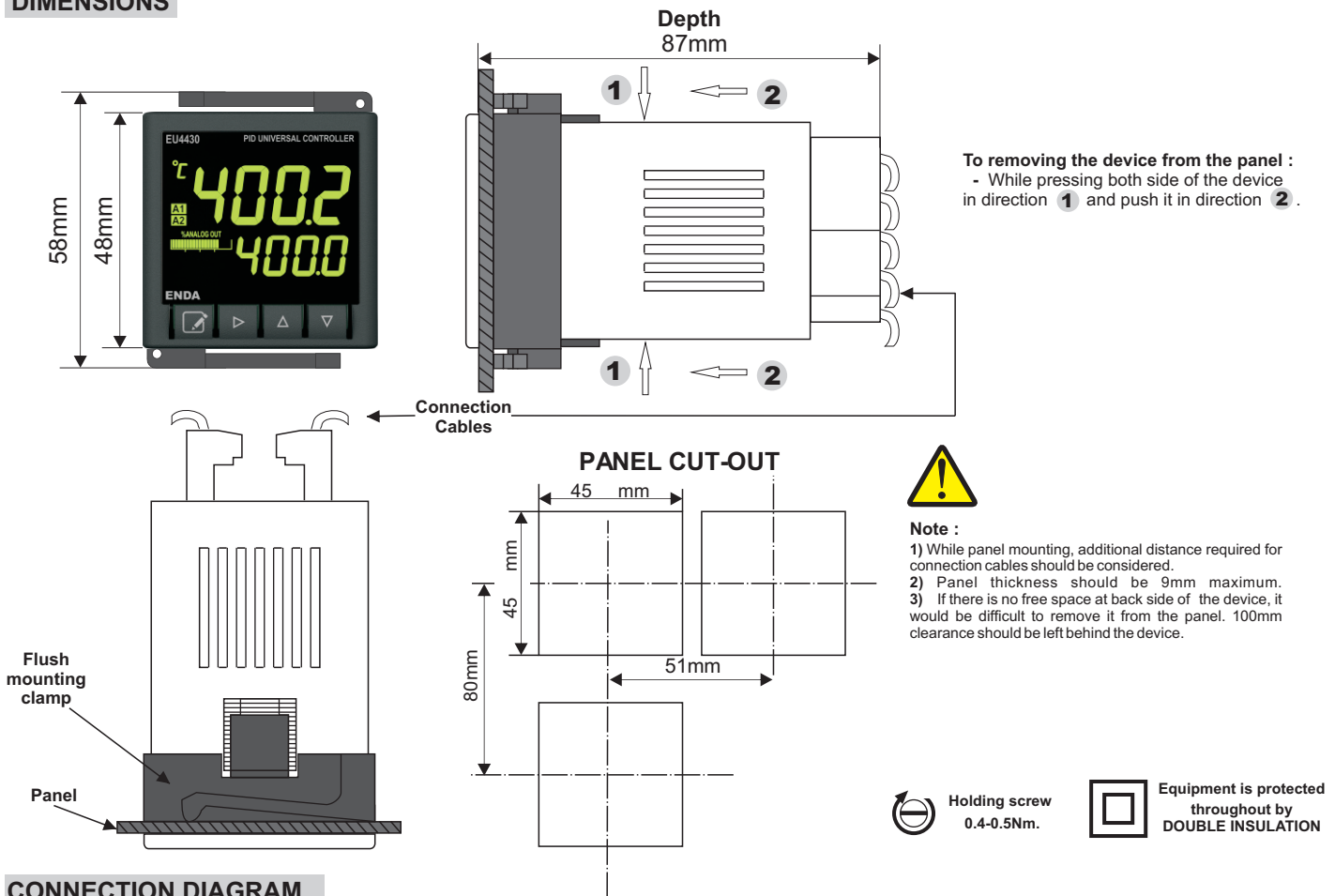

CONNECTION DIAGRAM

ENDA EU4430 PID Temperature Controllers are intended for installation in control panels. Make sure that the device is used only for intended purpose. The shielding must be grounded on the instrument side. During an installation, all of the cables that are connected to the device must be free of energy. The device must be protected against inadmissible humidity, vibrations, severe soiling. Make sure that the operation temperature is not exceeded. All input and output lines that are not connected to the supply network must be laid out as shielded and twisted cables. These cables should not be close to the power cables or components. The installation and electrical connections must be carried on by a qualified staff and must be according to the relevant locally applicable regulations

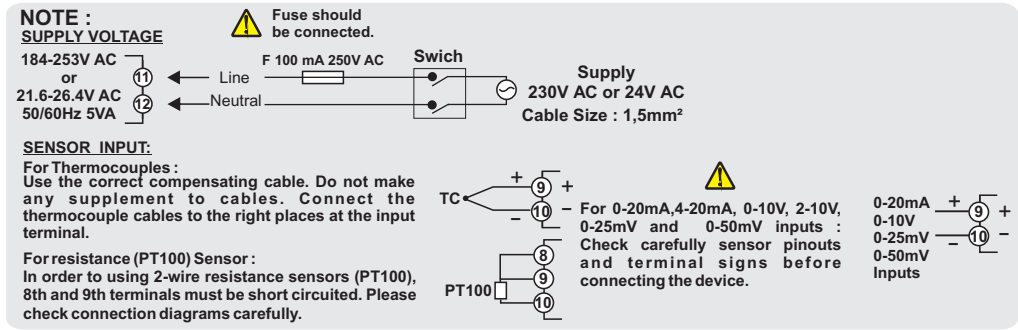
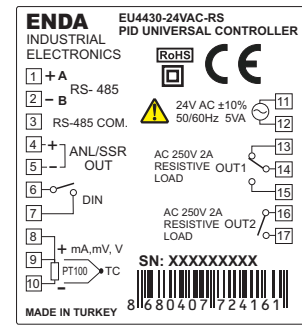
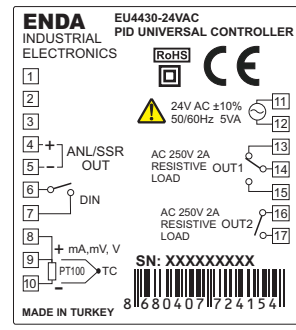
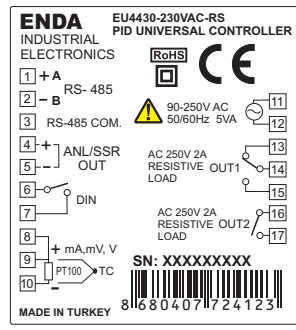
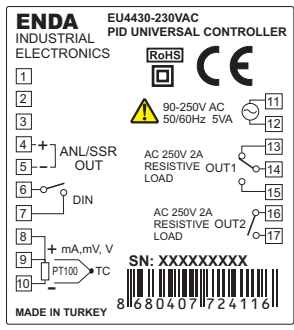

NOTE :
Logic output of the instrument is not electrically insulated from the internal circuits. Therefore, when using a grounding thermocouple, do not connect the logic output terminals to the ground.

Note :
1) Mains supply cords shall meet the requirements of IEC 60227 or IEC 60245.
2) In accordance with the safety regulations, the power supply switch shall bring the identification of the relevant instrument and it should be easily accessible by the operator.

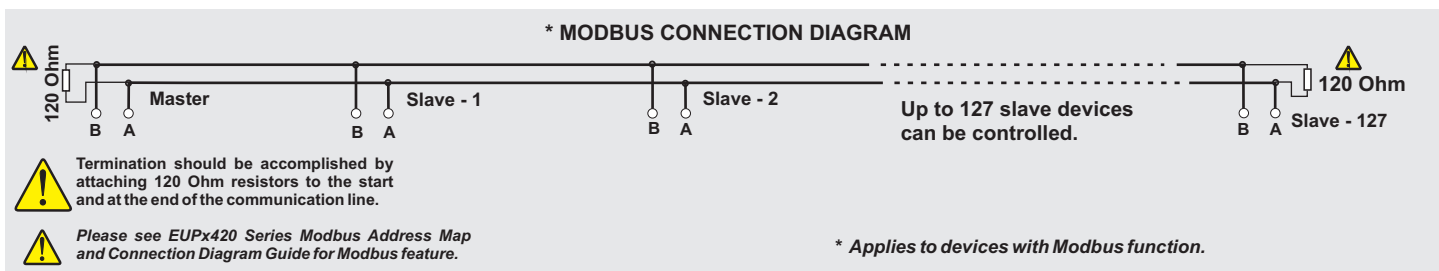

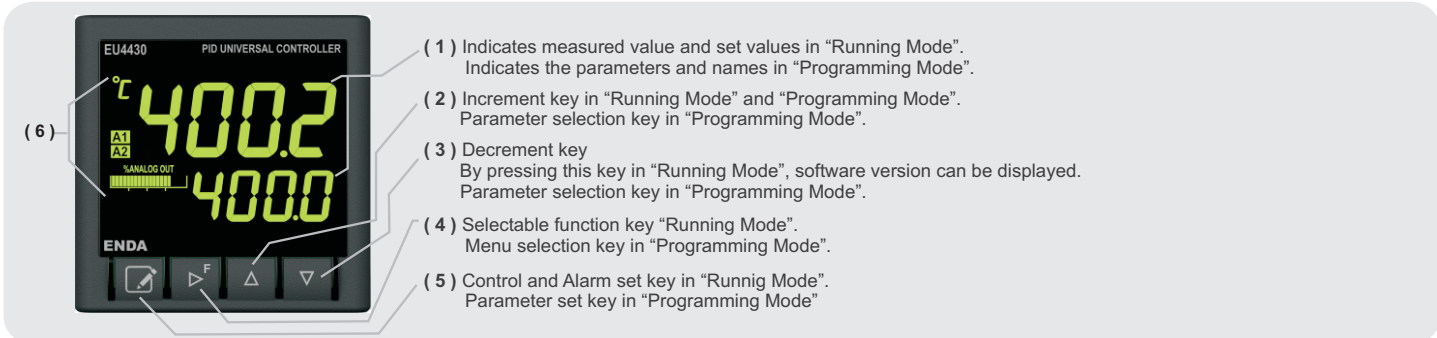

(1) PV and SV Indicators	PV 7 Segment 4 digits green LED , SV 7 Segment 4 digits green LED display.
Character Height	PV Display 12.0mm , SV Display 8.13mm
(2),(3),(4),(5) Keypads	Micro switch
(6) Status Indicators	Control, Alarm1, Alarm2, Analog output, SSR output and status indicator symbols.

ALARM1 AND ALARM2 OUTPUT TYPES

Independent Alarm
 $R\ i\ t\ P = i\ n\ d\ E$

(ASV min. = beginning of scale
ASV max. = end of scale)
SV = CONT output set value

Deviation Alarm
 $R\ i\ t\ P = d\ E$

(ASV min. = -300, ASV maks. = +300)
ASV = Alarm output set value

Band Alarm
 $R\ i\ t\ P = b\ A\ n\ d$

SV = CONT output set value ASV = AL1 output set value
(ASV min. = 0, ASV max. = +300)

Band Alarm With Inhibition
 $R\ i\ t\ P = b\ A\ n\ i$

SV = Set point of CONT output ASV = Set point of AL1 output (ASV min. = 0, ASV max. = 300)

SETTING UP ALARM CONTROL AND SETPOINT VALUES

3 seconds later

Tuşuna basılırsa kontrol ve alarm set değerleri ayar konumuna geçilir.

ERROR MESSAGES

PFR No communication with sensor. (Sensor and/or cable broken or not connected)

400 Temperature value is higher than scale.

-400 Temperature value is lower than scale.

If one of the $d\ i\ n\ c.$ or $F\ F\ E\ c.$ parameters are set to the $C\ 2\ 5\ R$ value, this parameter can be displayed.

If the $C\ a\ 5\ E$ parameter is set to SSR out, this parameter can be displayed.

If one of the $d\ i\ n\ c.$ or $F\ F\ E\ c.$ parameters are set to the $A\ R\ n\ u$ and if $C\ P\ b$ is different from 0, this parameter can be displayed.

ENDA EU4430 PROGRAMMING DIAGRAM

ENTERING TO PROGRAMMING MODE

If key is pressed while holding key, the "Programming Mode" is entered.

RUNNING MODE

During in "Programming Mode", if no key is pressed for 20 sec, settings automatically saved and device returns to the "Running Mode" (to the home screen). Alternatively, by pressing key "Running Mode" is entered and by pressing both keys at once, settings automatically saved and device returns to the "Running Mode" (to the home screen).

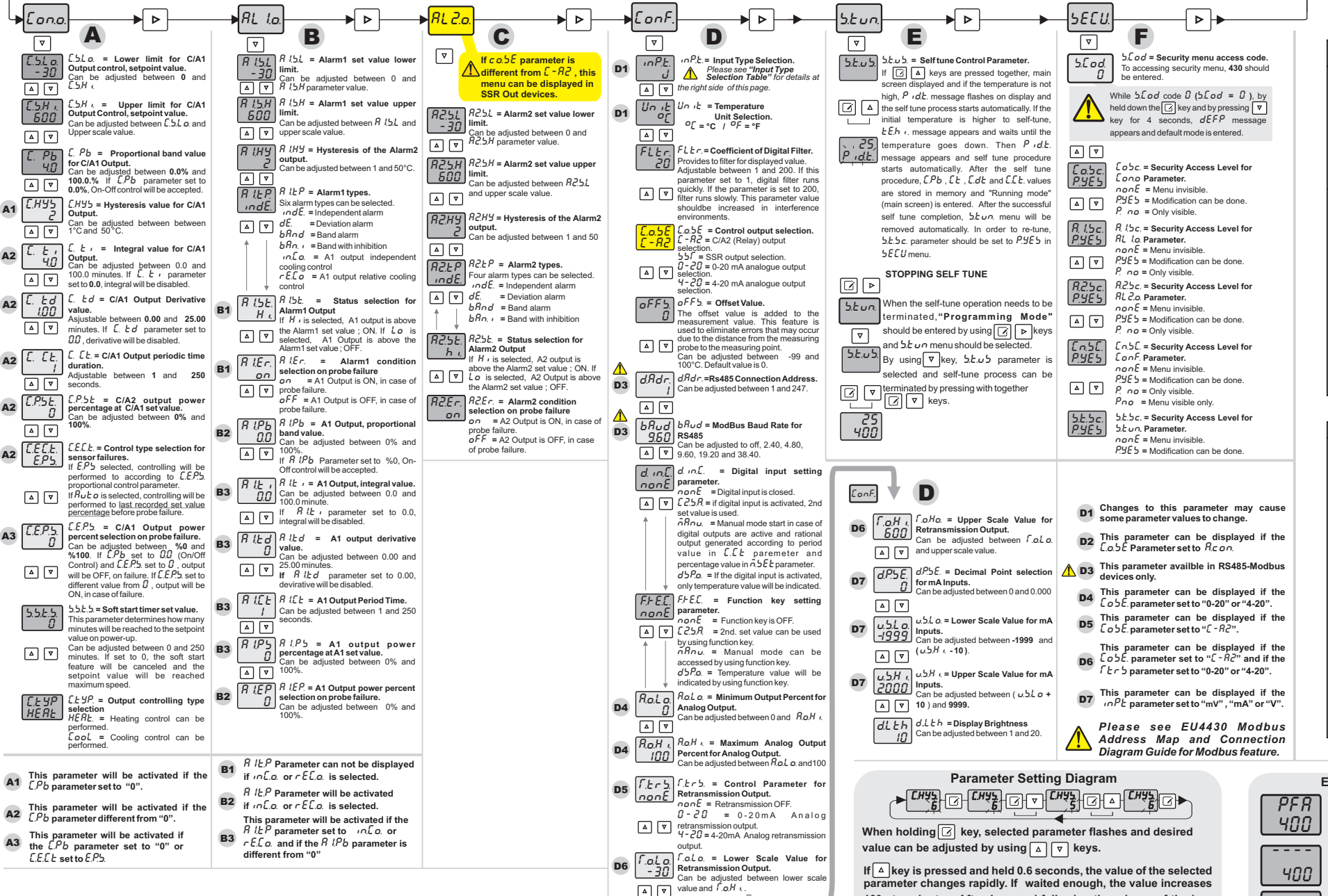

Warning: If **C05E** parameter is different from **C-R2**, this menu can be displayed in SSR Out devices.

ANNOTATIONS

Information tracking method of the parameters is as follows.

A B C D ...
 A: Alarm
 B: Alarm
 C: Alarm
 D: Alarm

On the device screens shown on this page;
 - First line indicates the parameter name,
 - Second line indicates the current parameter's value.
 At the same time, the value shown in the second line is the default value of the device.

R1E0 ⇨ Parameter name.
R1E0 ⇨ Parameter value (default value).

Input Type Selection Chart

inPt = Input Type selection.
Pt0 = PT100 - Decimal,
Pt = PT100 Non-decimal,
u0 = J Type - Decimal,
u = J Non-decimal,
t = K Type - Decimal,
L0 = L Type - Decimal,
L = L Non-decimal,
t0 = T Type - Decimal,
t = T Type,
s = S Type,
r = R Type

0-20 = 0-20 mA input,
 4-20 = 4-20 mA input,
 0-10 = 0-10 V input,
 2-10 = 2-10 V input,
 0-25 = 0-25 mV input,
 0-50 = 0-50 mV input.

Warning: Changes to this parameter may cause some parameter values to change.

ERROR MESSAGES

PFR
400
 No communication with sensor. (Sensor and/or cable broken or not connected)

400
 Temperature value is higher than scale.

400
 Temperature value is lower than scale.

Parameter Setting Diagram

When holding key, selected parameter flashes and desired value can be adjusted by using keys.

If key is pressed and held 0.6 seconds, the value of the selected parameter changes rapidly. If waited enough, the value increases 100 at each step. After 1 second following the release of the key, initial condition is returned. The same procedure is valid for the decrement key.

ENDA EU4430 PID TEMPERATURE CONTROLLER MODBUS PROTOCOL ADDRESS MAP

1.1 Memory Map for Holding Registers

	Parameter Number	Holding Register Address Decimal (Hex)	Data Type	Parameter Description	Read / Write Permission	Parameter Name	Default Value
Control Output Parameters	H0	0000d (0000h)	Word	Control output, temperature setpoint value	R/W	C15E	400
	H1	0001d (0001h)	Word	Control output, 2nd temperature setpoint value	R/W	C25E	400
	H2	0002d (0002h)	Word	Control output, minimum setpoint value	R/W	C5Lo	0
	H3	0003d (0003h)	Word	Control output, maximum setpoint value	R/W	C5Hi	600
	H4	0004d (0004h)	Word	Control output, proportional band setpoint value (Adjustable between 0.0% and 100.0%)	R/W	C.Pb	4
	H5	0005d (0005h)	Word	Control output, hysteresis value (Adjustable between 1 and 50 °C or °F)	R/W	CHYS	2
	H6	0006d (0006h)	Word	Control output, integral time (Adjustable between 0.1 and 100.0 minute)	R/W	C.ti	40
	H7	0007d (0007h)	Word	Control output, derivative time (Adjustable between 0.01 and 10.00 minute)	R/W	C.td	100
	H8	0008d (0008h)	Word	Control output, time period setpoint value (Adjustable between 1 and 125 second)	R/W	C.ct	20
	H9	0009d (0009h)	Word	Control output, set value power ratio (Adjustable between 0% and 100%)	R/W	CCPS	0
	H10	0010d (000Ah)	Word	Control output energy percentage in case of sensor error (can be set between 0% to 100%)	R/W	CEPS	0
A1 Output Parameters	H11	0011d (000Bh)	Word	Control output, soft start value	R/W	5555	0
	H12	0012d (000Ch)	Word	Alarm1 output temperature setpoint value	R/W	A15E	500
	H13	0013d (000Dh)	Word	Alarm1 output minimum setpoint value limit	R/W	A15L	0
	H14	0014d (000Eh)	Word	Alarm1 output maximum setpoint value limit	R/W	A15H	600
	H15	0015d (000Fh)	Word	Alarm1 output proportional band set value (Adjustable between 0.0% and 100.0%)	R/W	A1Pb	0
	H16	0016d (0010h)	Word	Alarm1 output hysteresis value (Adjustable between 1 and 50 °C or °F)	R/W	A1HY	2
	H17	0017d (0011h)	Word	Alarm1 output, integral time (Adjustable between 0.1 and 100.0 minute)	R/W	A1ti	0
	H18	0018d (0012h)	Word	Alarm1 output, derivative time (Adjustable between 0.01 and 10.00 minute)	R/W	A1td	0
	H19	0019d (0013h)	Word	Alarm1 output, time period setpoint value (Adjustable between 1 and 125 second)	R/W	A1ct	20
	H20	0020d (0014h)	Word	Alarm1 output, set value power ratio (Adjustable between 0% and 100%)	R/W	A1PS	0
	H21	0021d (0015h)	Word	Alarm1 output, set value power ratio in case of sensor failure (Adjustable between %0 and %100)	R/W	A1EP	0
A2 Output Parameters	H22	0022d (0016h)	Word	Alarm1 output type selection (Values can be given from 0 to 4) (0 = Independent alarm, 1 = Deviation alarm, 2 = Band alarm, 3 = Active alarm after in band time, 4 = Alarm1 output, cooling control selection)	R/W	A1tP	0
	H23	0023d (0017h)	Word	Alarm2 output, temperature setpoint value	R/W	A25E	500
	H24	0024d (0018h)	Word	Alarm2 output minimum setpoint value limit	R/W	A25L	0
	H25	0025d (0019h)	Word	Alarm2 output maximum setpoint value limit	R/W	A25H	600
	H26	0026d (001Ah)	Word	Alarm2 output, hysteresis value (Adjustable between 1 and 50 °C or °F)	R/W	A2HY	2
	H27	0027d (001Bh)	Word	Alarm2 output type selection (Values can be given from 0 to 3) (0 = Independent alarm, 1 = Deviation alarm, 2 = Band alarm, 3 = Active alarm after in band time)	R/W	A2tP	0
Configuration Parameters	H28	0028d (001Ch)	Word	Input selection number (0 = PT100 Decimal, 1 = Pt100 Non-decimal, 2 = J Decimal, 3 = J Non-decimal, 4 = K Decimal, 5 = K Non-decimal, 6 = L Decimal, 7 = L Non-decimal, 8 = T Decimal, 9 = T Non-decimal, 10= S Non-decimal, 11 = R Non-decimal, 12 = 0-20mA, 13 = 4-20mA, 14 = 0-10V, 15 = 2-10V, 16 = 0-25mV, 17 = 0-40mV)	R/W	inPt	5
	H29	0029d (001Dh)	Word	ModBus device address (Adjustable between 1 and 247)	R/W	dAdr	1
	H30	0030d (001Eh)	Word	Modbus communication speed (Baudrate) (0 = Modbus cancel, 1 = 2400 bps, 2 = 4800 bps, 3 = 9600 bps, 4 =19200 bps, 5 = 38400 bps)	R/W	bAud	3
	H31	0031d (001Fh)	Word	Digital filter coefficient (Adjustable between 1 and 200, 1 = filter is disable)	R/W	FLtr	10
	H32	0032d (0020h)	Word	Control output, selection value (0 = C/A2 Control output selection, 1 = SSR/ANL is SSR, 2 = SSR/ANL is 0-20mA, 3 = SSR/ANL is 4-20mA. ATTENTION !! H42 parameter will be 0 if this parameter set to different from 0.	R/W	C.o5E	0
	H33	0033d (0021h)	Word	Analog output minimum out percentage	R/W	RoLo	0
	H34	0034d (0022h)	Word	Analog output maximum out percentage	R/W	RoHi	100
	H35	0035d (0023h)	Word	Offset value	R/W	oFF5	0
	H36	0036d (0024h)	Word	Function control parameter. (23040d (5A00h) self tune stops when this value is entered) (23041d (5A01h) self tune starts when this value is entered) (23042d (5A02h) returns to factory defaults when this value is entered)	R/W	----	0
	H37	0037d (0025h)	Word	Reserverd	R/W	----	20
	H38	0038d (0026h)	Word	Reserverd	R/W	----	20
	H39	0039d (0027h)	Word	Manual control output percentage (can be adjusted between 0% and 100%)	R/W	n5Et	50

ENDA EU4430 PID TEMPERATURE CONTROLLER MODBUS PROTOCOL ADDRESS MAP

1.1 Memory Map for Holding Registers (continue)

	Parameter Number	Holding Register Address Decimal (Hex)	Data Type	Parameter Description	Read / Write Permission	Parameter Name	Default Value
Configuration Parameters	H40	0040d (0028h)	Word	Digital input control parameter (0 = Digital input off, 1 = 2nd set value can be selected by digital input, 2 = Manual mode can be entered via digital input, 3 = Can be switched to display mode via digital input)	R/W	d.inç.	0
	H41	0041d (0029h)	Word	Function key control parameter (0 = Function key off, 1 = 2nd Set value can be selected by function key, 2 = Manual mode can be entered by using function key, 3 = Can be switched to display mode by using function key)	R/W	Ft.Eç.	0
	H42	0042d (002Ah)	Word	Retransmission output control parameter: If this parameter is 0, Retransmission output; off If this parameter is 1, Analog output; 0-20mA Retransmission output If this parameter is 2, Analog output; 4-20mA Retransmission output ATTENTION!! To setting up this parameter, H32 parameter must be set to 0.	R/W	r.tr.b.	0
	H43	0043d (002Bh)	Word	Retransmission output lower scala value.	R/W	r.o.l.o.	0
	H44	0044d (002Ch)	Word	Retransmission output upper scala value.	R/W	r.o.H.i.	600
	H45	0045d (002Dh)	Word	Decimal Point selection for mA anv V inputs.	R/W	d.P.b.E.	0
	H46	0046d (002Eh)	Word	User defined lower scale value for 0-20mA, 4-20mA, 0-10V and 2-10V input selections	R/W	u.b.l.o.	0
	H47	0047d (002Fh)	Word	User defined upper scale value for 0-20mA, 4-20mA, 0-10V and 2-10V input selections	R/W	u.b.H.i.	9999
	H53	0053d (0035h)	Word	Display Brightness (can be adjusted between 1 and 20)	R/W	d.l.t.h	10
Security Parameters	H48	0048d (0030h)	Word	Control output menu, security parameter (0 = Menu invisible, 1 = Menu programmable, 2 = Menu only visible)	R/W	ç.o.b.c.	1
	H49	0049d (0031h)	Word	Alarm1 output menu security parameter (0 = Menu invisible, 1 = Menu programmable, 2 = Menu only visible)	R/W	A.1.b.c.	1
	H50	0050d (0032h)	Word	Alarm2 output menu, security parameter (0 = Menu invisible, 1 = Menu programmable, 2 = Menu only visible)	R/W	A.2.b.c.	1
	H51	0051d (0033h)	Word	Configuration menu, security parameter (0 = Menu invisible, 1 = Menu programmable, 2 = Menu only visible)	R/W	ç.n.b.c.	1
	H52	0052d (0034h)	Word	Self tune menu, security parameter (0 = Menu invisible, 1 = Self tune can be done)	R/W	b.t.b.c.	1

1.2 Memory Map for Coils

Parameter Number	Coil Address	Data Type	Parameter Description	Read / Write Permission	Parameter Name	Default Value
C0	(0000)h	Bit	Alarm2 condition (0 = Active Low ,1 =Active High)	R/W	A.2.b.t.	1
C1	(0001)h	Bit	Alarm2 condition selection on probe failure (0 = Off , 1 = On)	R/W	A.2.E.r.	0
C2	(0002)h	Bit	Alarm1 condition (0 = Active Low ,1 =Active High)	R/W	A.1.b.t.	1
C3	(0003)h	Bit	Alarm1 condition selection on probe failure (0 = Off , 1 = On)	R/W	A.1.E.r.	0
C4	(0004)h	Bit	Control output configuration (0 = Heat ; 1 = Cool)	R/W	ç.t.y.p.	0
C5	(0005)h	Bit	Temperature unit (0 = °C ; 1 = °F)	R/W	u.n.i.t	0
C6	(0006)h	Bit	Control outputs active (0 = Control outputs active, 1 = Only display mode)	R/W	----	0
C7	(0007)h	Bit	Controlling according to 2nd temperature setpoint (If C7 = 0 is H0, if C7 = 1 is H1)	R/W	----	0
C8	(0008)h	Bit	Auto/Manual selection (0 = Automatic "Running mode", 1 = Manual "Running mode". In this mode, output generated according to H39 parameter.)	R/W	----	0
C9	(0009)h	Bit	Control procedure in case of probe failure (0 = H10 proportional control according to percentage value, 1 = Error found before the setpoint control is done with the value of the proportional control)	R/W	ç.E.c.t.	0

1.3 Memory Map for Input Registers

Parameter Number	Input Register Address Decimal (Hex)	Data Type	Parameter Description	Read / Write Permission
I0	0000d (0000h)	Word	Measured temperature	R
I1	0001d (0001h)	Word	Analog output percentage	R
I2	0002d (0002h)	Word	Measurement error codes 0 = No error, 1 = Sensor short circuit, 2 = Lower scale error, 3 = Upper scale error, 4 = Sensor connection lost, 5 = Wrong input selection.	R
I3	0003d (0003h)	Word	Self tune condition codes 0 = No error, 1 = Initial temperature is higher than 60% setpoint value, 2 = Calculating PID parameters, 3 = Calculating power set parameters	R
I4	0004d (0004h)	Word	Current (active) temperature setpoint.	R
I5	0005d (0005h)	Word	Reserved	R
I6	0006d (0006h)	Word	Current (active) decimal point value (0 = No decimal point, 1 = 0.0 Decimal point is tenths)	R

1.4 Memory Map for Software Revision Input Registers

Software Revision	61472d (F020h)	14 Word	Software name and update is read in ASCII format and as 14 word. For example : EU4430-01 03 Feb 2017. Memory Formats : <div style="text-align: center;"> W₁rd W₂rd W₃rd W₄rd W₅rd W₆rd W₇rd W₈rd W₉rd W₁₀rd W₁₁rd W₁₂rd W₁₃rd W₁₄rd U E 4 4 0 3 0 - 1 3 0 F b e 2 1 0 . 7 </div>	R
NOTE : To view each word correctly by changing the byte sequences should be displayed as ASCII TEXT				

ENDA EU4430 PID TEMPERATURE CONTROLLER MODBUS PROTOCOL ADDRESS MAP

1.5 Memory Map for Discrete input

Parameter Number	Discrete Input Address	Data Type	Parameter Description	Read / Write Permission
D0	(0000)h	Bit	C/A2 Control output status (0 = OFF ,1 = ON)	R
D1	(0001)h	Bit	A1 Output status (0 = OFF , 1 = ON)	R
D2	(0002)h	Bit	SSR Output status (0 = OFF ,1 = ON)	R
D3	(0003)h	Bit	Digital input status (0 = OFF ,1 = ON)	R

2. MODBUS ERROR MESSAGES

Modbus protocol has two types error, communication error and operating error. Reason of the communication error is data corruption in transmission. Parity and CRC control should be done to prevent communication error. Receiver side checks parity and CRC of the data. If they are wrong, the message will be ignored. If format of the data is true but function doesn't perform for any reason, operating error occurs. Slave realizes error and sends error message. Most significant bit of function is changed '1' to indicate error in error message by slave. Error code is sent in data section. Master realizes error type via this message.

ModBus Error Codes

Error Code	Name	Description
01	ILLEGAL FUNCTION	The function code received in the query is not an allowable action for the slave. If a Poll Program Complete command was issued, this code indicates that no program function preceded it.
02	ILLEGAL DATA ADDRESS	The data address received in the query is not an allowable address for the slave.
03	ILLEGAL DATA VALUE	A value contained in the query data field is not an allowable value for the slave.

Message sample ;

Structure of command message (Byte Format)

Device Address	(0A)h
Function Code	(01)h
Beginning address of coils.	MSB (04)h
	LSB (A1)h
Number of coils (N)	MSB (00)h
	LSB (01)h
CRC DATA	LSB (AC)h
	MSB (63)h

Structure of response message (Byte Format)

Device Address	(0A)h
Function Code	(81)h
Error Code	(02)h
CRC DATA	LSB (B0)h
	MSB (53)h

As you see in command message, coil information of (4A1)h = 1185 is required but there isn't any coil with 1185 address. Therefore error code with number (02) (Illegal Data Address) sends.

* MODBUS CONNECTION DIAGRAM

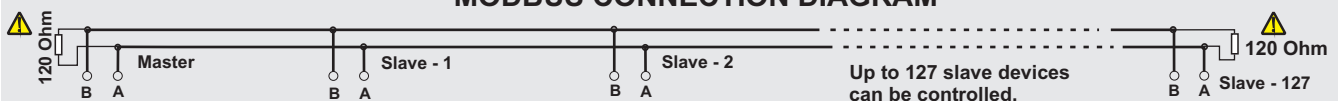

! Termination should be accomplished by attaching 120 Ohm resistors to the start and at the end of the communication line.

* Applies to devices with Modbus function.