

DC input side

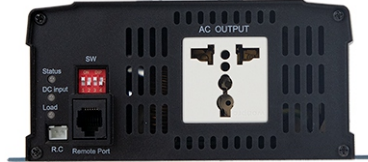

AC output side



IEC62368-1 BS EN/EN62368-1 (for 112/124 type GFCI only) TPTC004 AS/NZS 62368.1
Please refer to page3 for more details.

Features

- Compact size and light weight
- True sine wave output (THD<3%)
- High surge power up to 1500W
- Temperature controlled cooling fan
- AC output voltage and frequency selectable by DIP S.W
- No load dissipation <1.5W at standby saving mode
- -25°C~+70°C wide operating temperature
- Power ON-OFF remote control
- Front panel indicator for operation status
- Protections :

Input : Reverse polarity / DC low alarm / DC low shutdown / Over voltage

Output : Short circuit / Overload / Over temp.

- Battery over discharge protection(Low voltage disconnect)
- Suitable for lead-acid or li-ion batteries
- Remote controller
(IRC1, IRC2, IRC3 accessory sold separately, please refer to: <https://www.meanwell.com/webapp/product/search.aspx?prod=IRC1>)
- Support RS-232 communication(Communication cable order No.: RJ11-RS232, sold sperately)
- Carry handle accessory available(Order NO.: Carry handle, sold separately)
- Conformal coating
- 3 years warranty

Applications

- Home and office appliance
- Power tools
- Portable equipment
- Vehicle
- Yacht
- Off-grid solar power system
- Wireless network
- Telecom or datacom system

GTIN CODE

MW Search: <https://www.meanwell.com/serviceGTIN.aspx>

Description

NTS-750 is a 750W highly reliable off-grid true sine wave DC-AC power inverter. Its key features include: digital design with MCU control, streamlined control circuitry that quickly responds to environmental changes and improves reliability, high quality fan with low acoustic noise, 1500W peak power, adjustable AC output voltage and frequency, -25~+70°C wide operating temperature range, complete protection features, and etc. combined with batteries, the NTS-750 is suitable for use in residential, commercial, marine, automobile, mine, construction site, and remote areas with no access to utility power, and the output can be used to power fans, TV, radio, phone charger, PC/laptop, lighting, electromechanical tool, communication equipment, power distribution cabinet, outdoor camping equipment, marine AC power, factory equipment, and etc.

Model Encoding

NTS - 750 - 1 12 US

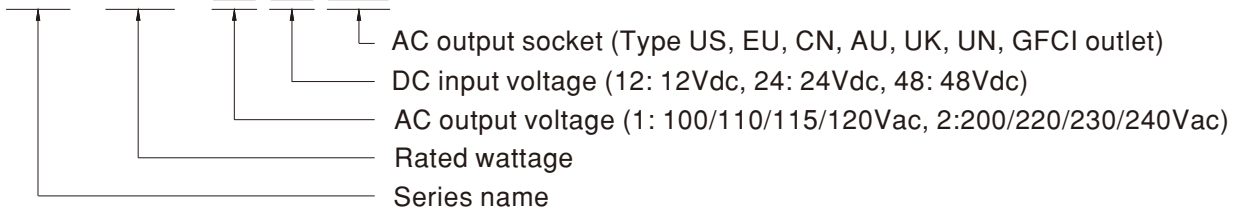

SPECIFICATION

| MODEL NO. | | NTS-750-112 <input type="checkbox"/> | NTS-750-124 <input type="checkbox"/> | NTS-750-148 <input type="checkbox"/> | NTS-750-212 <input type="checkbox"/> | NTS-750-224 <input type="checkbox"/> | NTS-750-248 <input type="checkbox"/> | | |
|-----------------------|---|--|--|--|---|---|--------------------------------------|-----------|---------|
| | | <input type="checkbox"/> = US, GFCI, UN | | | <input type="checkbox"/> = EU, CN, AU, UK, UN | | | | |
| AC OUTPUT | RATED POWER(Continuous) | 750W | | | | | | | |
| | OVER RATED POWER(3 Min.) | 862W | | | | | | | |
| | PEAK POWER(10 Sec.) | 1125W | | | | | | | |
| | SURGE POWER(30 Cycles) | 1500W | | | | | | | |
| | AC VOLTAGE | Default setting set at 110VAC 100 / 110 / 115 / 120Vac selectable by DIP S.W | | | Default setting set at 230VAC 200 / 220 / 230 / 240Vac selectable by DIP S.W | | | | |
| | FREQUENCY | Default setting set at 60Hz±0.1Hz 50/60Hz selectable by DIP S.W | | | Default setting set at 50Hz±0.1Hz 50/60Hz selectable by DIP S.W | | | | |
| | WAVEFORM <small>Note.1</small> | True sine wave (THD<3%) | | | | | | | |
| | AC REGULATION | ±3.0% at rated output voltage | | | | | | | |
| FRONT PANEL LED | Please see page5 | | | | | | | | |
| DC INPUT | DC VOLTAGE | 12V | 24V | 48V | 12V | 24V | 48V | | |
| | VOLTAGE RANGE (Typ.) | 10 ~ 16.5Vdc | 20 ~ 33Vdc | 40 ~ 66Vdc | 10 ~ 16.5Vdc | 20 ~ 33Vdc | 40 ~ 66Vdc | | |
| | DC CURRENT (Typ.) | 75A | 38A | 19A | 75A | 38A | 19A | | |
| | NO LOAD DISSIPATION (Typ.) | NON-SAVING MODE | 10W | 10W | 12W | 10W | 10W | 12W | |
| | | SAVING MODE | Default disable, ≤1.2W ~ 1.5W by models @ auto detect AC output load ≤10W will be changed to saving mode | | | | | | |
| | | | 1.2W | 1.4W | 1.5W | 1.2W | 1.4W | 1.5W | |
| | OFF MODE CURRENT DRAW | ≤1mA | | | | | | | |
| | EFFICIENCY (Typ.) <small>Note.1</small> | 89% | 90% | 91% | 90% | 93% | 93% | | |
| BATTERY TYPES | Lead Acid or li-ion | | | | | | | | |
| PROTECTION | DC INPUT | FUSE (Internal) | 40A*3 | 40A*2 | 25A*2 | 40A*3 | 40A*2 | 25A*2 | |
| | | LOW | ALARM | 11±0.3Vdc | 22±0.5Vdc | 44±1Vdc | 11±0.3Vdc | 22±0.5Vdc | 44±1Vdc |
| | | | SHUTDOWN | 10±0.3Vdc | 20±0.5Vdc | 40±1Vdc | 10±0.3Vdc | 20±0.5Vdc | 40±1Vdc |
| | | | RESTART | 12.5±0.3Vdc | 25±0.5Vdc | 50±1Vdc | 12.5±0.3Vdc | 25±0.5Vdc | 50±1Vdc |
| | | HIGH | ALARM | 15.5±0.3Vdc | 31±0.5Vdc | 62±1Vdc | 15.5±0.3Vdc | 31±0.5Vdc | 62±1Vdc |
| | SHUTDOWN | | 16.5±0.3Vdc | 33±0.5Vdc | 66±1Vdc | 16.5±0.3Vdc | 33±0.5Vdc | 66±1Vdc | |
| | RESTART | | 15±0.3Vdc | 30±0.5Vdc | 60±1Vdc | 15±0.3Vdc | 30±0.5Vdc | 60±1Vdc | |
| | BAT. POLARITY | | By internal fuse open | | | | | | |
| | AC OUTPUT | OVER TEMPERATURE | Protection type : Shut down o/p voltage, re-power on to recover(except 112/124GFCI) Shut down o/p voltage,recovers automatically after temperature goes down(for 112/124GFCI) | | | | | | |
| | | OUTPUT SHORT | Protection type : Shut down o/p voltage, re-power on to recover | | | | | | |
| OVER LOAD (Typ.) | | 105 ~ 115% load for 180 sec., 115% ~ 150% load for 10 sec. Protection type : Shut down o/p voltage, re-power on to recover | | | | | | | |
| GFCI PROTECTION | | UL458 (Only for "GFCI" AC socket, by request) | | | None | | | | |
| FUNCTION | REMOTE CONTROL | Power ON-OFF remote control by front panel dry contact connector (by RELAY), Open : Normal work ; Short : Remote off | | | | | | | |
| | DRY CONTACT ACCESSORY | Remote controller sold separately, Order No.: IRC1,IRC2,IRC3 | | | | | | | |
| ENVIRONMENT | RS-232 COMMUNICATION | RS-232 ~ RJ11 Type connector (Please refer to page 4 for more details) | | | | | | | |
| | WORKING TEMP. | -25 ~ +70°C (Refer to "Derating curve") | | | | | | | |
| | WORKING HUMIDITY | 20% ~ 90% RH non-condensing | | | | | | | |
| | STORAGE TEMP., HUMIDITY | -30 ~ +70°C / -22 ~ +158°F, 10 ~ 95% RH non-condensing | | | | | | | |
| SAFETY & EMC (Note.4) | VIBRATION | 10 ~ 500Hz, 3G 10min./1cycle, 60min. each along X, Y, Z axes | | | | | | | |
| | SAFETY STANDARDS | CB IEC62368-1, Dekra BS EN/EN62368-1, UL458, E13, EAC TP TC 004 approved; Design refer to AS/NZS 62368.1 (Please refer to next page "AC output socket" table for more details) | | | | | | | |
| | WITHSTAND VOLTAGE | DC I/P - AC O/P: 3.0KVac AC O/P - FG: 1.5KVac | | | | | | | |
| | EMC EMISSION | Parameter | Standard | | | | Test Level / Note | | |
| | | | Radiated | FCC for 112, 124, 148 only(expect for Type-UN) | | | Class A | | |
| | | | BS EN/EN55032(CISPR32) for 212, 224, 248 only(expect for Type-UN) | | | Class A | | | |
| | | Harmonic Current | BS EN/EN61000-3-2 | | | | | ----- | |
| | Voltage Flicker | BS EN/EN61000-3-3 | | | | | ----- | | |
| EMC IMMUNITY | BS EN/EN55024, BS EN/EN55035 | | | | | | | | |
| | Parameter | Standard | | | | Test Level / Note | | | |
| | ESD | BS EN/EN61000-4-2 | | | | Level 3, 8KV air ; Level 2, 4KV contact | | | |
| | Radiated | BS EN/EN61000-4-3 | | | | Level 2, 3V/m | | | |
| Magnetic Field | BS EN/EN61000-4-8 | | | | Level 1, 1A/m | | | | |
| OTHERS | MTBF | 715.7K hrs min. Telcordia TR/SR-332 (Bellcore); 78K hrs min. MIL-HDBK-217F (25°C) | | | | | | | |
| | DIMENSION | 270*158*67mm (L*W*H) | | | | | | | |
| | PACKING | 2.3Kg; 4pcs/ 10.2Kg/ 1.9CUFT | | | | | | | |
| NOTE | <p>1.Efficiency, AC regulation and THD are tested by 600W, linear load at 12.5Vdc/25Vdc/50Vdc input voltage.</p> <p>2.All parameters not specified above are measured at rated load, 25°C of ambient temperature and set to factory setting.</p> <p>3.Internal pre-start circuit, the setup time is 8s.</p> <p>4.The power supply is considered as an independent unit, but the final equipment still need to re-confirm that the whole system complies with the EMC directives. For guidance on how to perform these EMC tests, please refer to "EMI testing of component power supplies." (as available on https://www.meanwell.com/Upload/PDF/EMI_statement_en.pdf)</p> <p>※ Product Liability Disclaimer : For detailed information, please refer to https://www.meanwell.com/serviceDisclaimer.aspx</p> | | | | | | | | |

■ AC Output Socket

| MODEL NO. | NTS-750-112 <input type="checkbox"/> | NTS-750-124 <input type="checkbox"/> | NTS-750-148 <input type="checkbox"/> | NTS-750-212 <input type="checkbox"/> | NTS-750-224 <input type="checkbox"/> | NTS-750-248 <input type="checkbox"/> | | |
|-------------|--------------------------------------|--------------------------------------|--------------------------------------|--------------------------------------|--------------------------------------|--------------------------------------|------------|-----------|
| Socket type | | | | | | | | |
| | TYPE-US | TYPE-GFCI | TYPE-UN | TYPE-EU | TYPE-CN | TYPE-UK | TYPE-AU | TYPE-UN |
| | In Stock | By request | In Stock | In Stock | In Stock | By request | By request | In Stock |
| Country | USA | USA | UNIVERSAL | EUROPE | CHINA | U.K | AUSTRALIA | UNIVERSAL |
| Certificate | | | None | | | | | |

■ DERATING CURVE

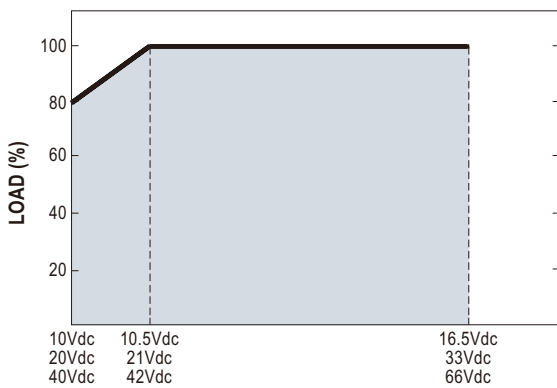
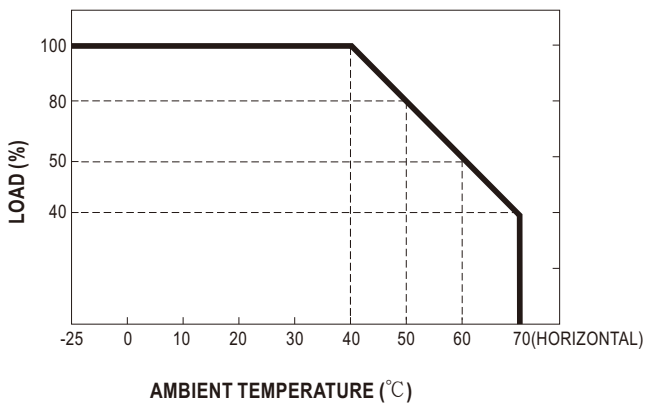

IRC1/2/3 Remote Controller (Accessory sold separately)

- IRC1/IRC2/IRC3 is the monitoring and control unit.
 - IRC1/IRC2/IRC3 can decode the RS-232 signals sent by the inverter series and display through digital meters.
- Note: Part of the control signals will not function properly due to different compliance of each model.

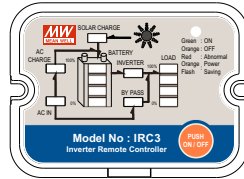
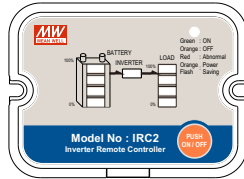
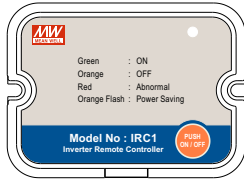

※ Please refer to for more detail: <https://www.meanwell.com/webapp/product/search.aspx?prod=IRC1>

Support RS-232 Communication

- The internal data of single NTS-750 can read through RS-232.

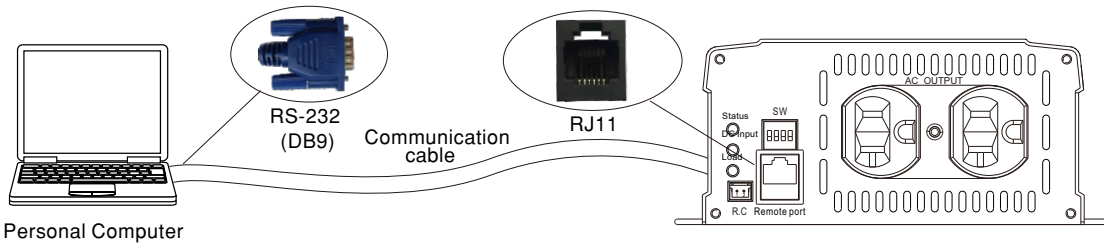

※ Please refer to for more detail: <http://www.meanwell.com/manual.html>

※ RJ11-RS232 Communication cable should be ordered separately, Order No.: RJ11-RS232

Remote ON-OFF Control (Built-in)

| | |
|---------------|--------------------|
| Remote ON-OFF | AC Output Status |
| Open | power inverter ON |
| Short | power inverter OFF |

AC Output Voltage, Frequency, Power saving mode selectable by DIP SW

Output voltage and frequency setting factory settings are either 110Vac/60Hz or 230Vac/50Hz, users are able to adjust the voltage and frequency, through the DIP switch of position 1,2,3,4 on the panel.

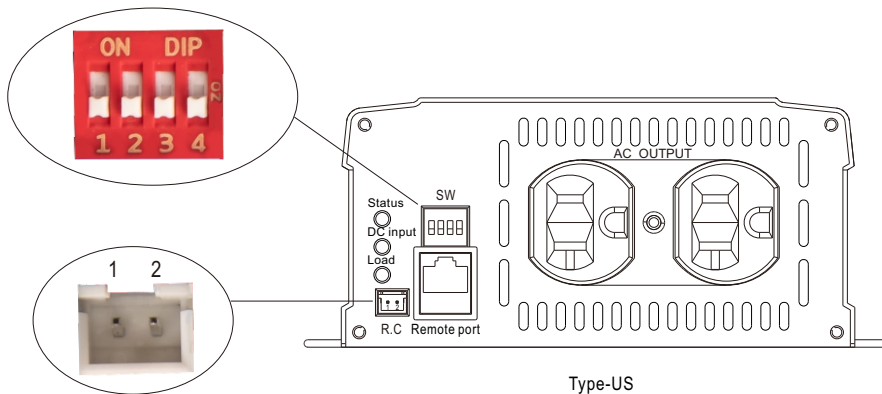















Type-US



| AC Output Voltage, Frequency, Power saving mode selectable by DIP SW | | | |
|--|------------------------|-----------|----------------------|
| SW1 | SW2 | SW3 | SW4 |
| OFF | OFF : 100Vac or 200Vac | ON : 50Hz | ON : Saving mode |
| OFF | ON : 110Vac or 220Vac | | |
| ON | OFF : 115Vac or 230Vac | OFF: 60Hz | OFF: Non-Saving mode |
| ON | ON : 120Vac or 240Vac | | |

■ LED STATUS













Normal work:



| | Green | Orange | Red |
|---------------|---|---|---|
| Status |  System check  Inverter OK |  Remote off  Saving mode |  Abnormal Status <small>(See below table)</small> |

| | Green | Orange | Red |
|-----------------|--|--|--|
| DC Input |  12.5~15.5Vdc  25~31Vdc  50~62Vdc |  11~12.5Vdc  22~25Vdc  44~50Vdc |  <11Vdc or >15.5Vdc  <22Vdc or >31Vdc  <44Vdc or >62Vdc |

| | Green | Orange | Red |
|-------------|---|---|---|
| Load |  <40% load |  40~80% load |  >80% load |

Abnormal status :

| LED Indicator | Abnormal Indication |
|---|--|
| Status  DC Input  Load  | Output overload or AC output short circuit |
| Status  DC Input  Load  | Abnormal DC voltage |
| Status  DC Input  Load  | Over temperature or Fan lock |
| Status  DC Input  Load  | Inverter fail |

-  Light
-  Light off
-  Flash

MECHANICAL SPECIFICATION

(Unit: mm , tolerance ± 1 mm)

Unit:mm

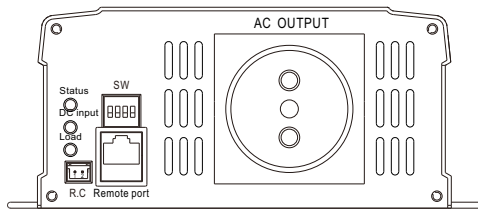
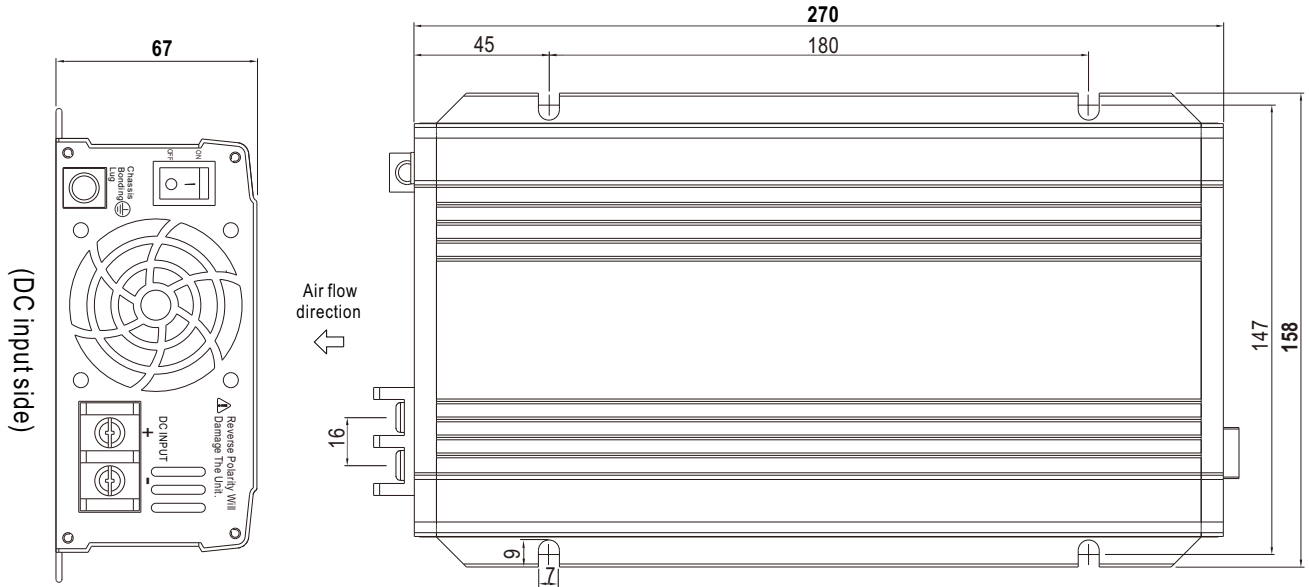

Type-EU

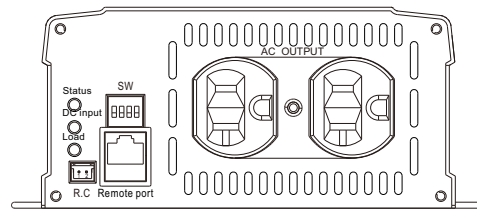

Type-US

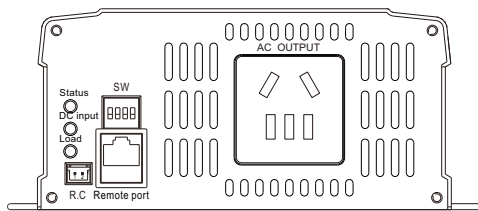

Type-CN

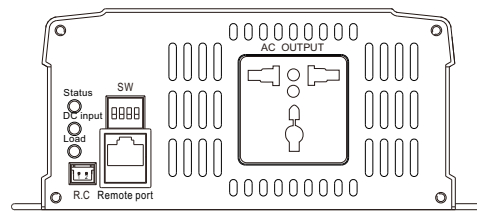

Type-UN

(AC output side)

R.C Connector : JST B-XH or equivalent

| Remote Control | Mating Housing | Terminal |
|---------------------------|--------------------------|-------------------------------|
| Pin 1,2 Open: Normal work | JST XHP or equivalent | JST SXH-001T or equivalent |
| Pin 1,2 Short: Remote off | | |

Remote port connector (RJ11)

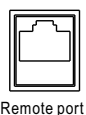



| Assignment | Rx | GND | Tx |
|-------------|----|-----|----|
| Remote port | 2 | 3 | 4 |
| DB9 | 3 | 5 | 2 |

■ Accessory List

※ Communication cable (Optional accessory, Power inverter and Communication cable should ordered separately)

| MW's Order No. | Item | Quantity |
|----------------|---|----------|
| RJ11-RS232 |  | 1 |

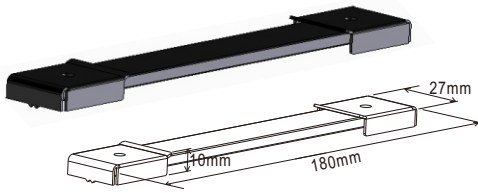
※ Carry handle (Optional accessory, Power inverter and Pull handle should ordered separately)

| MW's Order No. | Item | Quantity |
|----------------|--|----------|
| Carry Handle | ① Handle  | 1 |
| | ② Foot pad  | 4 |
| | ③ Screw  | 2 |

① Handle

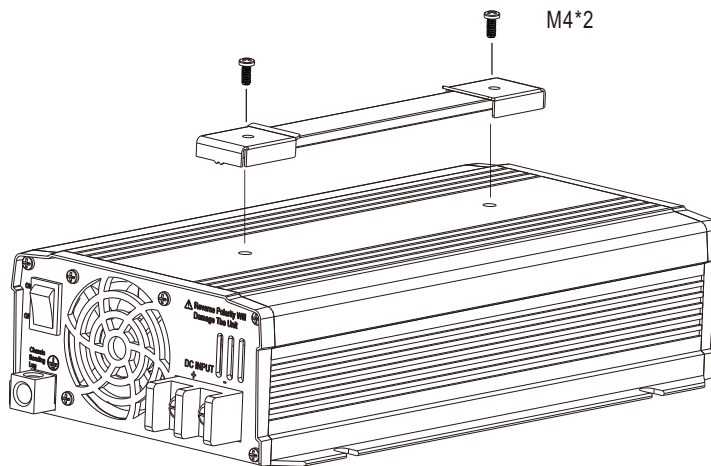

② Foot pad

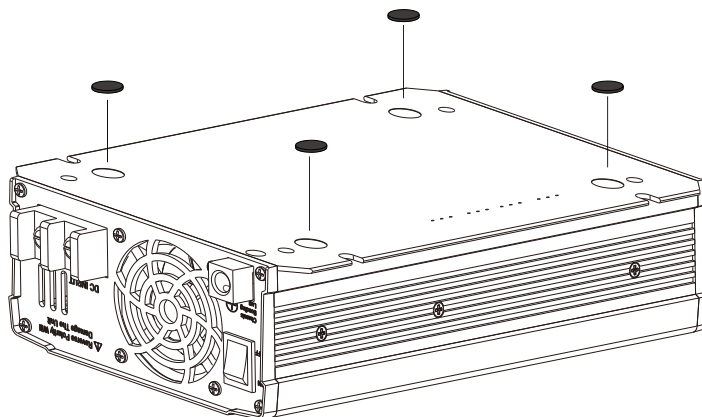

■ TYPICAL APPLICATION



- 1 Battery Bank
- 2 Off-Grid DC/AC Solar Inverter (NTS series)
- 3 AC Outlet



- 1 Utility Input (Shore)
- 2 AC/DC Battery Charger (PB/NPB/NPP series)
- 3 Battery Bank
- 4 Off-Grid DC/AC Power Inverter (NTS series)
- 5 AC Outlet

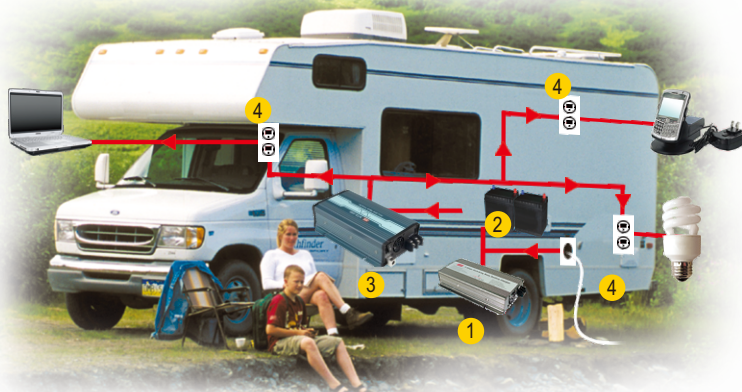

- 1 AC/DC Battery Charger (PB/NPB/NPP series)
- 2 Battery Bank
- 3 Off-Grid DC/AC Inverter (NTS series)
- 4 AC Outlet

■ INSTALLATION MANUAL

Please refer to : <http://www.meanwell.com/manual.html>