

## Features

- Class I structure
- Rated input voltage: 100-120Vac/200-240Vac ~ 50/60Hz
- Compliant with EMC EN55035/55032 Class A conducted/ radiated emission requirements.
- Operating temperature up to 70°C
- Over-voltage Category: III
- Low standby power consumption, standby power consumption < 0.5W
- OVP/OLP/SCP protection.
- 3 years warranty



## Applications

Industrial control system, industrial equipment, power system, rail transportation, lighting system



## Model list

Model No.	Input Voltage	Power max.	Output Voltage	Output Current max.	Efficiency typ.	Ripple Voltage	Voltage ADJ.
DL-450W-V12-EXC	100-240Vac	450W	12Vdc	0-37.5A	≥87%	240mV	±10%
DL-450W-V15-EXC	100-240Vac	450W	15Vdc	0-30.00A	≥88%	240mV	±10%
DL-450W-V24-EXC	100-240Vac	450W	24Vdc	0-18.75A	≥88%	240mV	±10%
DL-450W-V36-EXC	100-240Vac	450W	36Vdc	0-12.50A	≥88%	360mV	±10%
DL-450W-V48-EXC	100-240Vac	450W	48Vdc	0-9.38A	≥88%	360mV	±10%

Remark:

1. The above parameters are tested under the following conditions: Ta = 25°C, 230Vac input, and after 30 minutes of full load operation.
2. Ripple and noise measurement method: use a 12" twisted-pair wire terminated with 0.1μF & 47μF parallel capacitor, and measured at 20MHz bandwidth.

## Input characteristics

Parameter	Min.	Typ.	Max.	Remark
Rated input voltage	100-120Vac 140Vdc	230Vac	200-240Vac 370Vdc	250-370Vdc (Switch to 230VAC)
Input voltage range	90Vac	-	264Vac	90~132Vac/180~264Vac On-off selection
Rated frequency	47Hz	50/60Hz	63Hz	-
Power factor	-	>0.5	-	100% load, 230Vac
T.H.D.	-	N/A	-	-
Input current/115Vac	-	-	10A	100% load, 115Vac
Input current/230Vac	-	-	5A	100% load, 230Vac
Inrush current/115Vac	-	-	82A	115Vac, cold start (25°C)
Inrush current/230Vac	-	-	155A	230Vac, cold start (25°C)
Leakage current	-	-	0.75mA	RMS Max.

## Output characteristics

Parameter	Min.	Typ.	Max.	Remark
Output tolerance	-	±1%	-	0-100% load
Line regulation	-	±1%	-	Rated load
Load regulation	-	±1%	-	@230Vac
Setup/Rise Time	-	-	500ms/30ms	@230Vac
Hold up time	16ms	-	-	100Vac, rated load

## Protection

Function	Description
Output overload protection	Protection mode: hiccup mode, recovers automatically after fault condition is removed.
Output short-circuit protection	Hiccup mode: recovers automatically after fault condition is removed
Output overvoltage protection	Output voltage > working voltage 1.08-1.5times turn-off

## Environmental

Environmental Categories	Parameter
Rated working temperature	-40 ~ +50°C@100-240Vac
Max. operating temperature range	-40 ~ 70°C; When the operating temperature exceeds 50°C, the power will be reduced by 2% for per 1° C increase in temperature. please refer to the derating curve for details.
Working humidity	20 ~ 90% RH, non-condensing
Storage temperature, humidity	-30~+85°C, 10 ~ 95% RH non-condensing
Vibration	10 ~ 500Hz, 5G 12min/cycle, 72 min, each along X, Y, Z axes
MTBF	230Khrs min. MIL-HDBK-217F (Ta=25°C)
Lifetime	50000 hours@230Vac, ambient temperature 20°C, please refer to "Lifetime/ Ambient temperature curve"

## Safety and EMC

Safety categories	Standard
Safety	Compliance to UL62368-1, TUV BS EN/EN62368-1, BS EN/EN60335-1, BS EN/EN61558-1/-2-16,GB 4943.1
EMC	EMI BS EN/EN55032, EN55035, Class A
	ESD BS EN/EN 61000-4-2
	EFT/Burst BS EN/EN 61000-4-4
Surge protection	Differential mode L-N $\pm$ 2KV (2 $\Omega$ ), common mode L, N-G $\pm$ 4 KV (12 $\Omega$ ) Harmonic Current Refer to IEC61000-4-5 2014
Withstand voltage	I/P-O/P:4KVac I/P-PE :2KVac O/P-PE: 1.25KVac
Insulation resistance	I/P-PE:100M $\Omega$ / 500VDC; I/P-O/P:100M $\Omega$ / 500Vdc / 25°C/ 70% RH

Note: The power supply is considered a component which will be installed into the terminal equipment. The EMC is affected by the entire equipment. The terminal equipment must be reconfirmed to meet the EMC directives.

## Parametric curves

### Power/ Efficiency curve

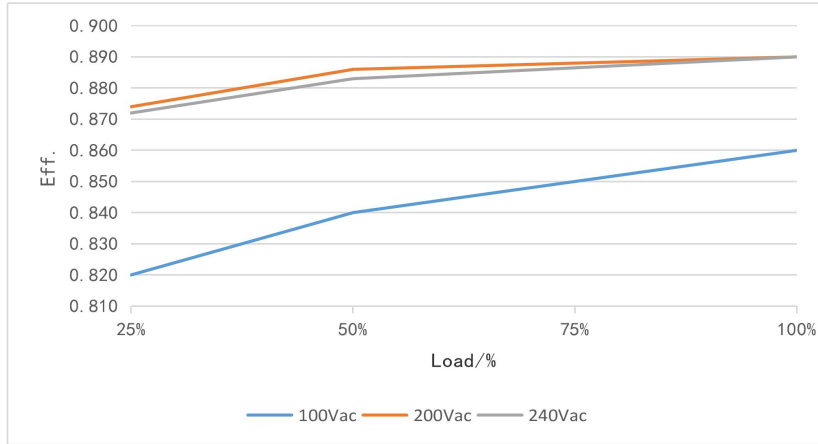

### Power/ Ambient temperature

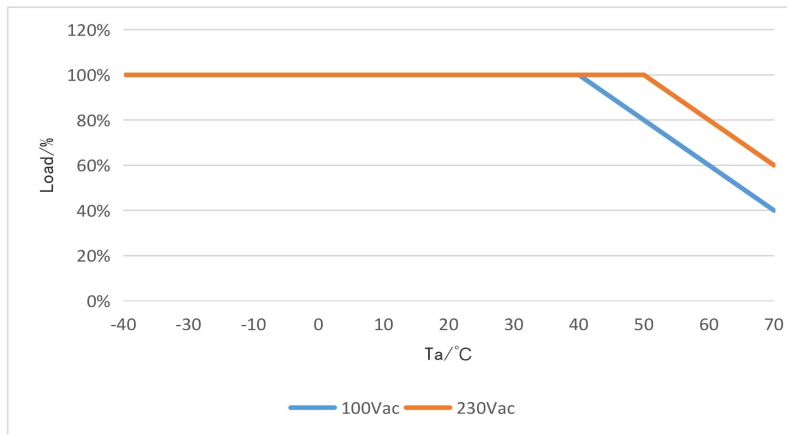

### Power/ Input voltage

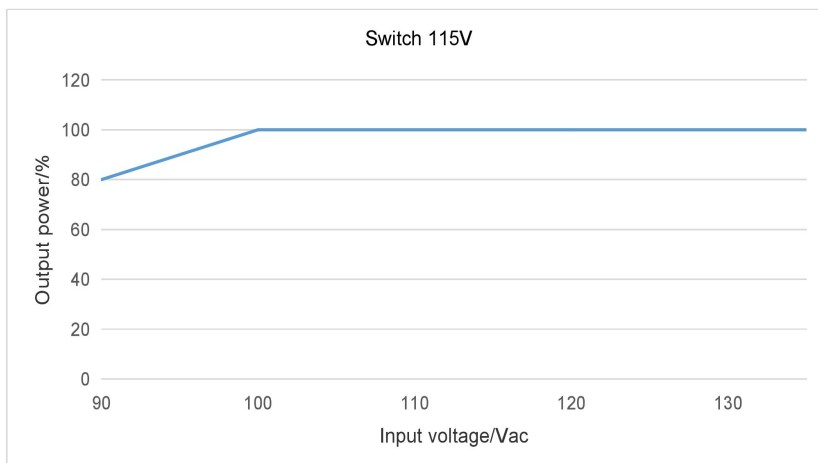

Power/ Input voltage

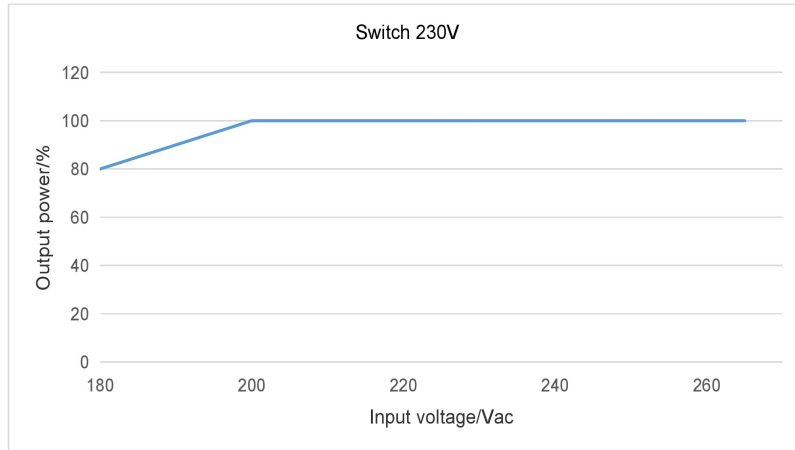

Lifetime/ Ambient temperature

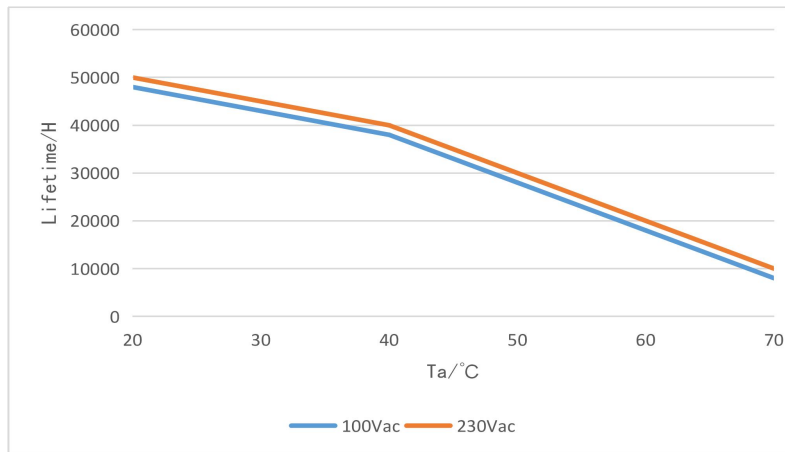

Inrush current

Input voltage	Peak current	T (@50% peak current)
100Vac	156A	261us
230Vac	155A	233us
264Vac	165A	250us

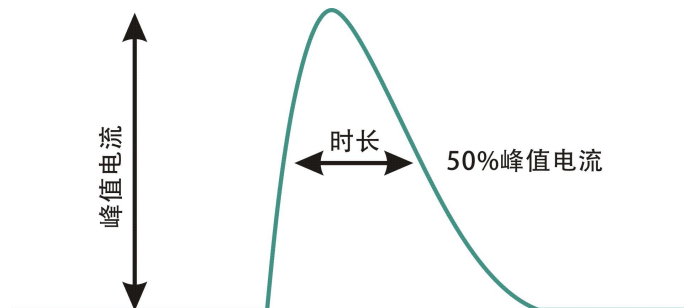

## Mechanical specification

### Weight

Size	L215mm*W115mm*H30mm
Weight	686g

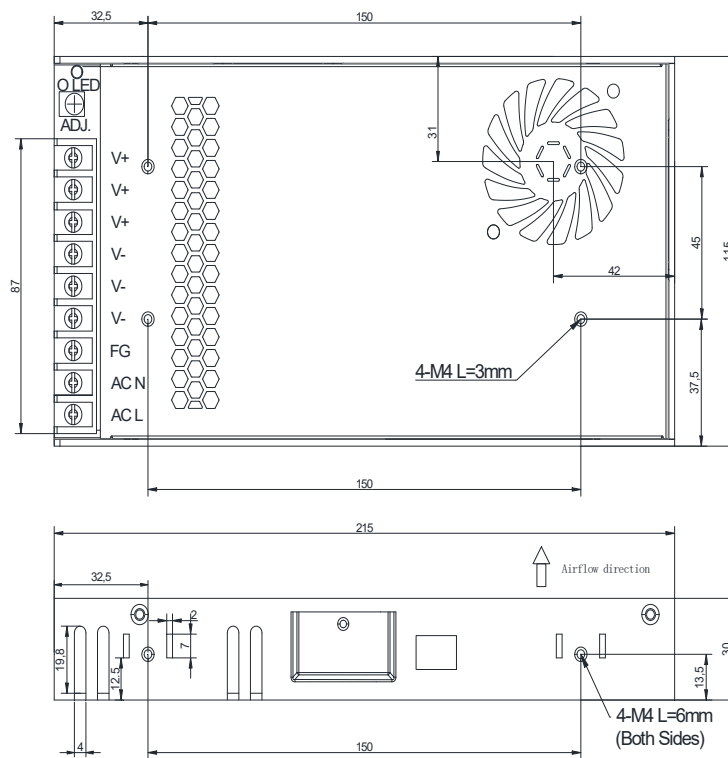

## Packaging

packaging (mm)

L457mm\*W252\*H194mm

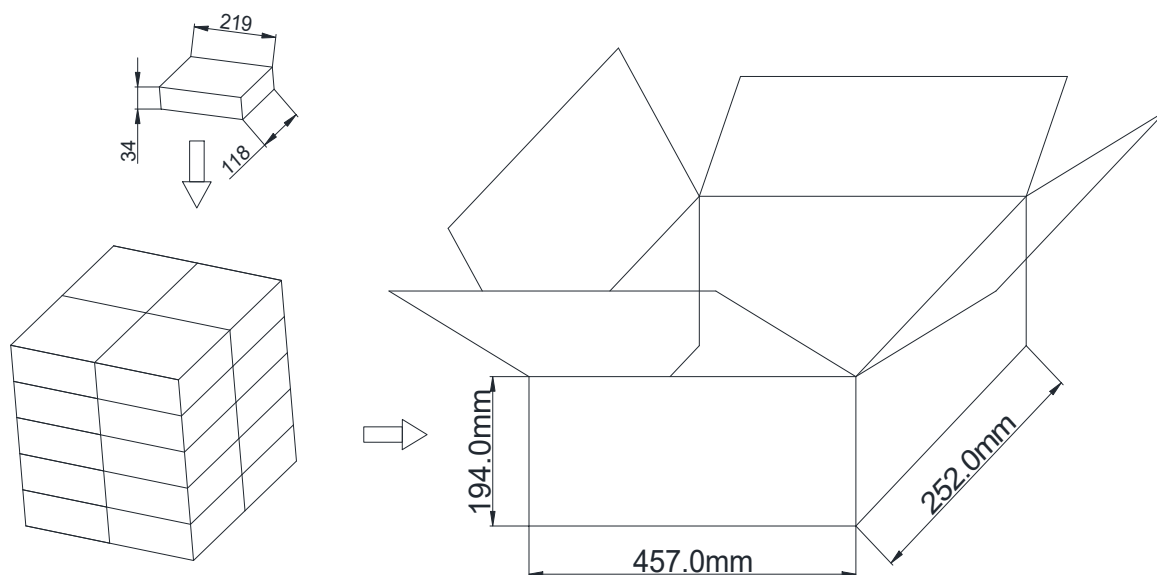
**NOTE:**

1. Each box has 5 layers, with 4 pieces on each layer, totaling 20 pieces per box.
2. According to the certificates obtained by LED DRIVER, LED DRIVER with English labels are sold in Europe, America and India.
3. LED driver power supplies with Chinese labels are only for the Chinese market.