	Product Information LVR15-8	Manufacturer	LEO
		Address	China,Zhejiang,Wenling
		Contact	0576-89988888
		Date	2023/06/18
Project Name		Client Name	LEO Sibir LLC
		Client Addr.	Novosibirsk
Item NO		Contacts	Maksim Sokolov
		Contact	+79059301333

Part NO.	50005544
----------	----------

Product Picture	Note
	<p>LVR series vertical multistage centrifugal pump is applicable to transfer liquids without solid particles<0.2mm and fiberslow viscositynon-inflammable non-explosive and not easy vaporization. Widely used in high-rise building water supply and drainageWater filtration and transportation, pipeline pressurization. High pressure flushing and cleaning system. Boiler feed water, cooling water circulation, water treatment system and other equipment supporting system. Ultrafiltration system, reverse osmosis system, distillation system, separator, swimming pool and other water treatment systems. Irrigation and drip irrigation systems in agriculture. food and beverage and fire fighting systems.</p>

Nameplate parameters

flow	15 m ³ /h
head	96 m
speed	2900 rpm
number of stages	8

Technical

Flow range (m ³ /h)	8-23m ³ /h
Curve tolerance	ISO 9906 Annex A
Head range (m)	

Material

Impeller	AISI 304
Diffuser	AISI 304
Pump shaft	AISI 304
Pump flange	0
Motor base	0
Coupling	ferrous powder metallurgy
Pump barrel	AISI 304



Working conditions

Medium temperature (°C)	-20°C ~ +120°C
Max. ambient temperature (°C)	+40°C
Pumped medium	Clean water
Working pressure	25bar
Maximum inlet pressure	10bar

Installation

Connection method	DIN flange
Inlet / outlet dia.	DN50

Motor

Motor phase	Three phase
Protection class	IP55
Motor poles	2
Insulation class	F
Motor power (KW)	7.5kW
Motor model	YX3-132S2-2
Frequency	50Hz
Rated voltage (V)	380V

	Product Information LVR15-8	Manufacturer	LEO
		Address	China,Zhejiang,Wenling
		Contact	0576-89988888
		Date	2023/06/18
Project Name		Client Name	LEO Sibir LLC
		Client Addr.	Novosibirsk
Item NO		Contacts	Maksim Sokolov
		Contact	+79059301333

Rated current (A) 14.53A
Efficiency class IE2
Power factor 0.89
Efficiency (%)

Weight/Packaging

Net weight (kg) 83.6
Gross weight (kg) 94.55
Package size 1190*340*380mm





Performance Curve LVR15-8

Manufacturer	LEO
Address	China,Zhejiang,Wenling
Contact	0576-89988888
Date	2023/06/18
Client Name	LEO Sibir LLC
Client Addr.	Novosibirsk
Contacts	Maksim Sokolov
Contact	+79059301333

Project Name

Item NO

The hydraulic performance curve have been tested with Clean Water at 20°C, density 1000kg/m³, and at 1bar atmospheric pressure. GB32162016 Grande 3B

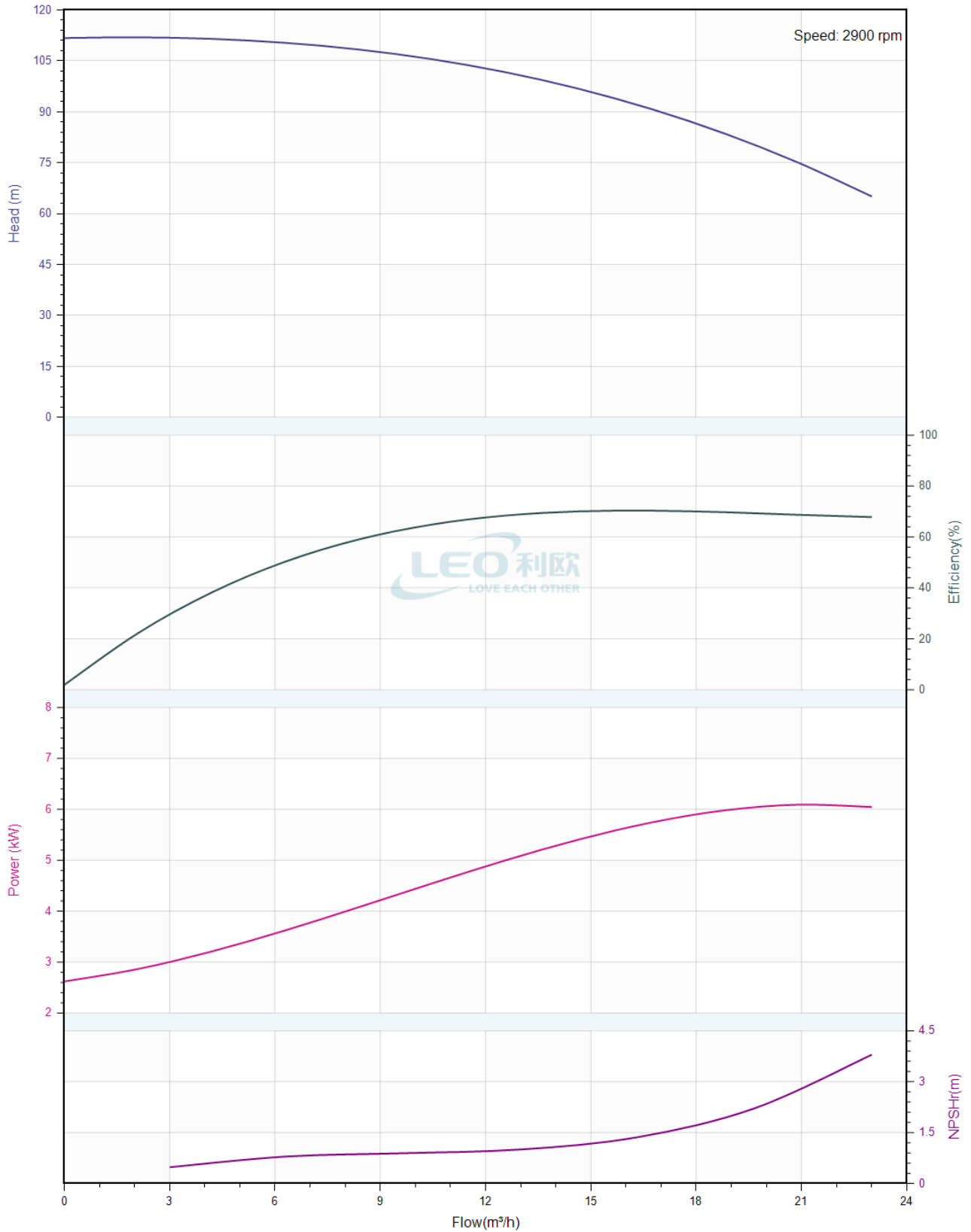



Pump Technical Parameters

LVR15-8

Manufacturer	LEO
Address	China,Zhejiang,Wenling
Contact	0576-89988888
Date	2023/06/18
Client Name	LEO Sibir LLC
Client Addr.	Novosibirsk
Contacts	Maksim Sokolov
Contact	+79059301333

Rated parameters

Pump model	LVR15-8
Part NO.	50005544
Rated flow	15 m ³ /h
Rated head	96 m
Rated efficiency (%)	70
Power (kW)	5.61
Speed (rpm)	2900

Medium

Pumped medium	Clean Water
Working temperature (°C)	20
Medium density (kg/m ³)	1000
Viscosity (mm ² /s)	1

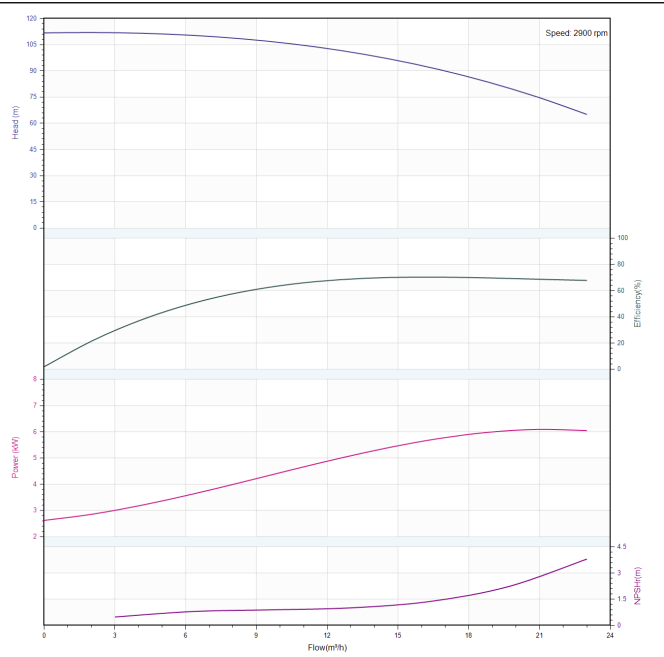





Dimension Drawing
LVR15-8

Manufacturer	LEO
Address	China,Zhejiang,Wenling
Contact	0576-89988888
Date	2023/06/18
Client Name	LEO Sibir LLC
Client Addr.	Novosibirsk
Contacts	Maksim Sokolov
Contact	+79059301333

Project Name

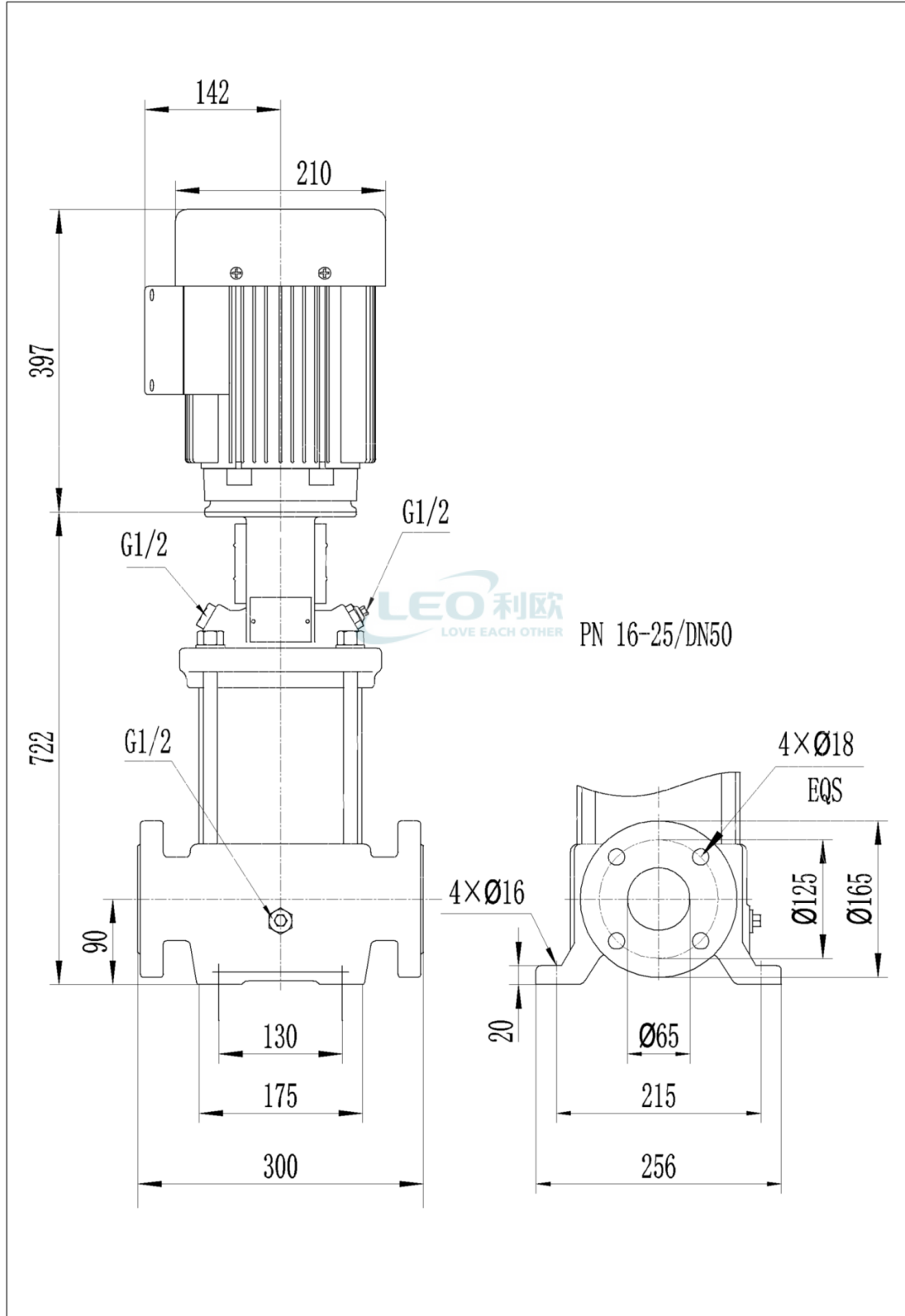
Item NO



	Order Data LVR15-8	Manufacturer	LEO
		Address	China,Zhejiang,Wenling
		Contact	0576-89988888
		Date	2023/06/18
Project Name		Client Name	LEO Sibir LLC
		Client Addr.	Novosibirsk
Item NO		Contacts	Maksim Sokolov
		Contact	+79059301333

Pump model LVR15-8
 Part NO. 50005544
 Product price
 Quantity 1
 Total price

Inquiry notes

